



The Sign of Quality  
Made in Germany

# SFU 0300

Schnellfrequenzumrichter  
High Frequency Converters





HIGH QUALITY

100%

MADE IN  
GERMANY



EXCELLENT SERVICE

# Content

Issue November 2021

Rev.1.2

1	Introduction	3
2	Description and Features	4
3	Block Diagram	5
4	Technical Data	6
5	Intended Use / Safety Precautions and Warnings	7
6	Connections, Interfaces and Pinout	8
6.1	Digital and Analogue Inputs and Outputs	9
6.2	Spindle Connection (DeskTop)	10
6.3	Spindle Connection SSE	10
6.4	Mains Supply	10
7	Functions, Commissioning, Operation	11
7.1	View at the Front Panel	11
7.2	Configuration of Rotational Speed	12
7.3	Configuration of Direction of Rotation	12
7.4	Selection of Spindle Characteristics	12
7.5	Starting and Stopping the Frequency Converter	13
7.6	Remote controlled Configuration of Direction of Rotation	14
7.7	Error messages – Error numbers	14
7.8	List of Errors indicated with red LED	15
7.9	Safety Functions	15
8	Calibration and Configuration using Windows Software	16
9	EMC (Electro-Magnetic Compatibility)	16
10	Mechanics, Views + Dimensions	17
11	Quality Commitment	19

## 1. Introduction

Depending on its construction, the speed of a three-phase asynchronous AC motor is directly dependent on the number of poles and the frequency of the voltage network. In a 3ph/50Hz network, with a 2-pole motor, the rated speed would be  $50 \text{ U/s} * 60 = 3000 \text{ rpm}$ .

With synchronous motors (brushless DC), the speed is dependent on the voltage applied.

Three-phase AC motors offer numerous advantages in industrial applications, such as brushless drive, no wear, favourable power/weight ratio, high speed capability, and much more. Your field of application is correspondingly diverse, e.g. for driving spindles in milling, grinding or drilling machines.

Synchronous motors have the advantage of a higher degree of efficiency (approx. 85%) compared to asynchronous motors (approx. 67%) with the disadvantage of not quite achieving the torque of an AC motor at low speeds and also not being able to achieve its high speeds. But due to the higher efficiency, the cooling requirement and also the size are smaller.

For the control of modern spindle motors, frequency converters are used which convert the rigid 50Hz network into a frequency- and voltage-variable 3-phase network. This means that three-phase motors can also be operated at much higher speeds than with pure 50Hz operation. The motors are controlled according to a special spindle characteristic up to the desired nominal speeds, accelerated in the load case efficiently regulated and if necessary controlled to a standstill.

The **SFU 0300** - series frequency converter has been specially designed for use in these high frequency applications, offering excellent safety, performance and reliability, the result of years of experience in the design and construction of frequency converters, together with the use of the latest materials and the most reliable components. It can be used in many different applications and is as equally suitable for use as a replacement device in existing systems with older type series as it is in pre-planned applications as a cost-effective solution, helping to prolong the useful life of tools.

This unit is designed exclusively for **operation in an industrial environment**. ( Chap. 5 / Chap. 9)

## 2. Description and Features

- ✓ Operation of **Asynchronous-AC –Spindles**
- ✓ With optionally available integrated **sinusoidal filter** for special smoothing of the output signal and operation of low-voltage spindles. This ensures high attenuation of interference emissions on the motor cables
- ✓ The frequency converter **SFU 0300** allows **output frequencies** up to **4000 Hz / 240.000rpm** with 2-pole asynchronous-AC-motors.
- ✓ **High Output power (1500VA/S1-100% )** in a compact format
- ✓ The Kernel of the **SFU-0300** is a **Digital Signal Processor (DSP)**, which generates all output variables and captures signals.
- ✓ All parameters, such as current, voltage and frequency, are captured in **real time**, and adjusted depending on the load condition
- ✓ High level of **operational safety**. All operating states such as acceleration, operation at rated speed, and deceleration, are monitored and critical statuses are intercepted and brought under control. This also includes the **controlled deceleration** of the motor / spindle in the event of power failure or Emergency Stop.
- ✓ **Control:** The frequency converter can be manually controlled and calibrated as required using 2 keys on the front panel.
- ✓ **Individual adaptation** to the application in hand and the spindle in use. Up to 16 different spindle characteristics can be stored in the memory of the frequency converter.
- ✓ **Diverse control and communication possibilities.** for connection to peripheral devices to - PC , PLC (Programmable Logic Control), CNC (Computer Numeric Control).
- ✓ **Straight-forward and flexible integration** into existing systems by means of open configuration of I/O signals for control and configuration:
  - Control inputs: 1 analogue, 3 digital
  - Control outputs: 1 analogue, 2 digital (relay)
- ✓ **Integrated board chopper-resistor** for quick braking even from high speeds
- ✓ **Galvanic separation** of all interfaces from the network / motor potential
- ✓ **Two housing options:** Desktop DT and Cabinet Mounting SSE
- ✓ **Short-circuit-protected**
- ✓ **User-friendly configuration** and control using optional Windows Software for the PC

### 3. Block Diagram

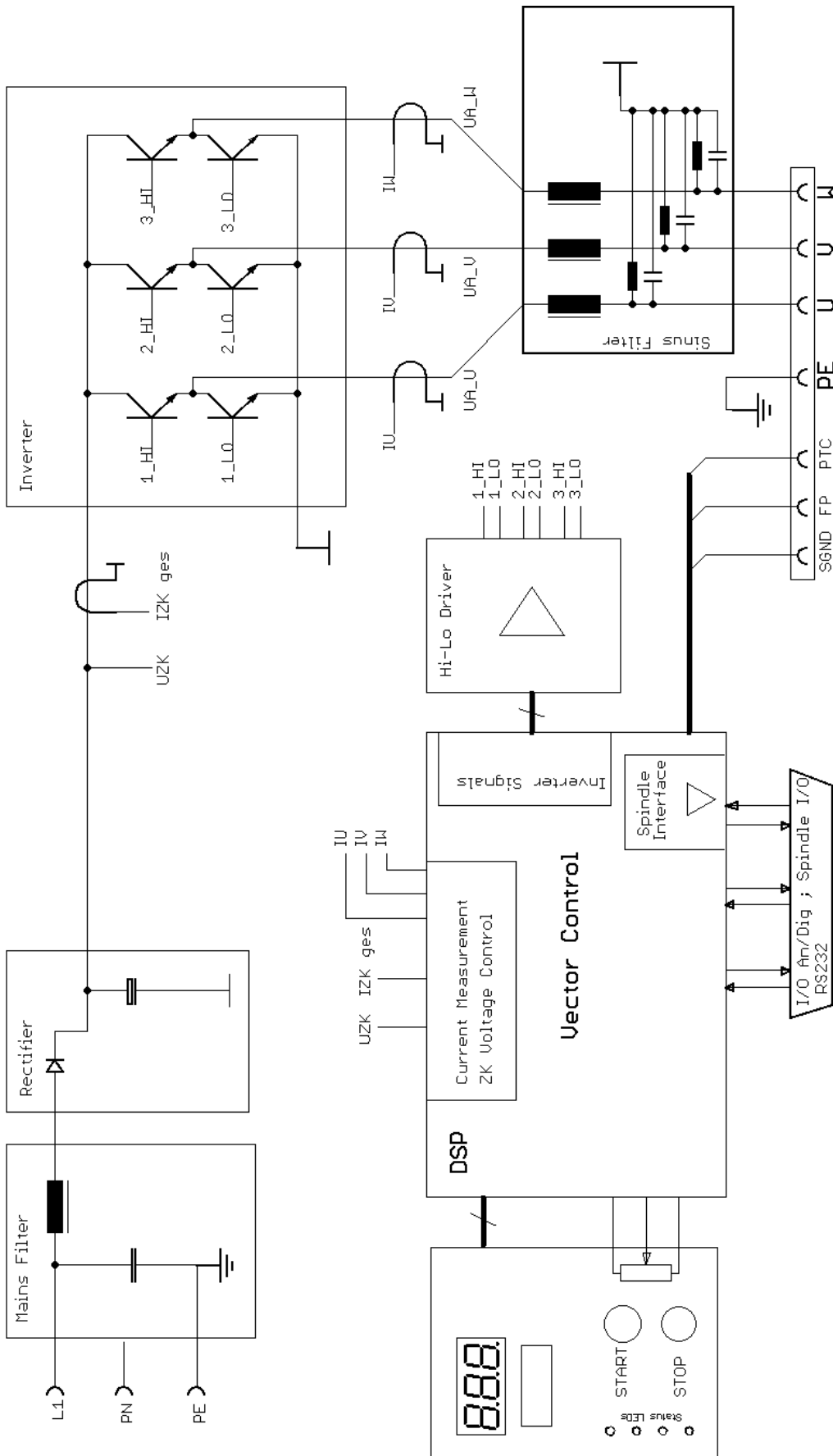

## 4. Technical Data

	SFU 0300 DeskTop	SFU 0300 SSE
Supply connection	230 V, 50Hz, 1PH	
Output Power	1.500 VA / S1-100%	
Spindle Connection	circular Plugs 7-pin: U, V, W, PE, PTC, FP, SGND	Pluggable Screw Terminals 8-pin 4mm <sup>2</sup> : U, V, W, 2*PE, PTC, FP, SGND
Output Voltage	3 * 230V	
Continuous Current	4,5A	
Peak Phase Current	9,0A	
Overcurrent	Adjustable Delay max. 20s	
Output Frequency	1.667Hz / 100.000 rpm	
Spindle characteristics	max. 16, stored internally	
Control inputs	1 analogue: 0-10V 3 digital: 0-24,V	
Control outputs	1 analogue: 0-10V 2 digital: relay outputs, 24VDC/1000mA, 125VAC/500mA	
Interface	RS232 galvanically isolated	
Dimensions B x H x T (mm)	DeskTop: 243 x 94 x 268	SSE : 90 x 312 x 268
Weight	ca. 4,6kg	ca. 4,9kg
Protection	IP20	
Operating Conditions	5 - 40°C / rel. humidity of air max. 85 %	



### ATTENTION:

Please ensure to have the proper spindle characteristic selected, always!  
The operation of a spindle with a wrong characteristic may harm the spindle or converter severely!



### ATTENTION:

In case of replacing the fuses, please ensure to use types only, which are mentioned above



### ATTENTION:

Operation at 115V is possible, but with reduced output power

## 5. Intended Use / Safety-Precautions and Warnings

- ✓ This unit is designed for operation **in industrial environments only**. When used in residential and commercial areas, additional measures may be required to limit emitted interference.
- ✓ During installation, applicable safety regulations must be observed.
- ✓ Before switching on the inverter for the first time, ensure that it is fixed and that the connected spindle is also securely fixed and cannot make any uncontrolled movements.
- ✓ Compliance with EMC (Electro Magnetic Compatibility) limits is the responsibility of the manufacturer of the machine or device. To increase immunity to interference and to reduce emitted interference, the inputs and outputs of this unit are equipped with filters. This makes operation in an industrial environment possible in principle.
- ✓ The EMC of a machine or a device is influenced by all connected components (motor, cables, wiring, ...). Under certain conditions, it may be necessary to connect external filters to ensure compliance with the applicable EMC standards.
- ✓ This unit generates dangerous electrical voltages and is used to operate dangerous rotating mechanical tools. For this reason, only professionally qualified, trained personnel may work on this unit and carry out the connection!
- ✓ Before putting the unit into operation, make sure that it is in perfect condition. If it has been damaged during transport, it must not be connected under any circumstances.
- ✓ The inverter must not be operated near heat sources, strong magnets or devices generating strong magnetic fields.
- ✓ Sufficient air circulation around the inverter must be ensured. The heat sink must not be covered.
- ✓ No liquid must be allowed to enter the unit. If this appears to be the case, the unit must be switched off and disconnected from the mains.
- ✓ The ambient air must not contain any aggressive, highly flammable or electrically conductive substances and should be as free of dust as possible.
- ✓ All work on the inverter and the corresponding accessories may only be carried out when it is switched off and disconnected from the mains. The national accident prevention regulations as well as the general and regional assembly and safety regulations (e.g. VDE) must be observed.
- ✓ All work in connection with one of our inverters may only be carried out by persons who are professionally qualified and have been instructed accordingly.



## 6. Connections, Interfaces and Pinouts

Operational parameters and outputs:

The **SFU 0300** covers all current important operational parameters and operating data. Up to 5 digital outputs can be used for signalling and 1 analogue value (0...10V) can be output at the analogue output.

Remote Control and Outputs:

3 digital inputs (0/24V) and 1 analogue inputs (0...10V) are available for remote control of the **SFU 0300**.

These assignments can be freely configured. Using the optional Windows PC software **SFU-Terminal** the above assignments can be easily achieved, providing exceptional flexibility with each application.

Each operating parameter can be assigned as a signal and each control signal can be allocated the required I/O pin. In addition, the logic level (high or low active) can be individually defined.

The same assignment is also possible for the analogue measured data and control data at the analogue I/O pin.

The standard allocations of operational parameters, their outputs, control signals and inputs, are listed in the following table.

## 6.1 Digital und Analog Ein-Ausgänge (D-Sub 15 pol. Buchse)

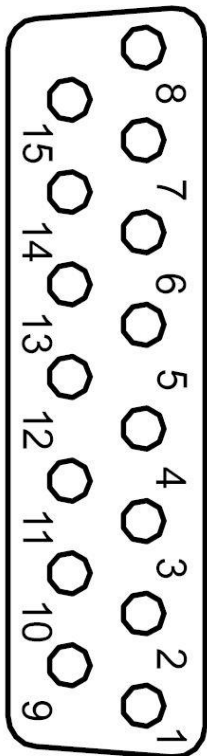

Pin	Function	Description
1	Common Relay	
2	Relay 1 (normally closed)	"Set Value Rotational Speed Reached"
3	Relay 1 (normally open)	"Set Value Rotational Speed Reached"
9	Relay 2 (normally closed)	"Overload Spindle"
10	Relay 2 (normally open)	"Overload Spindle"
6	+24V	Auxillary voltage +24V to PIN8 on option: contact of Relay 3 n.o.
4	Analogue Output	Effektive Load Condition 1V = 10%
11	Analogue Input	Set Calue Rotational Speed
12	Digital Input 1	Start/Stop
8	Ground	
7	Speed Sensor Output	
5	Digital Input 3	Direction of Rotation
13	RxD	(RS232)
14	TxD	(RS232)
15	Digital Input 2	Locking (Emergency Stop)

### USB-Adapter

Moreover a RS232-USB Dongle is available, which fits to the Dsub-15 socket and realizes an USB-port here, too. This will be an easy solution with other housing versions, where a USB is required



## 6.2 Spindle Connector with circular Jack

with 7 pin female jack (Amphenol C16-1 / Binder 693)

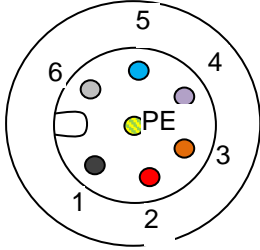

Pin	Function	Description
1	U	Spindle Phase 1
2	PTC	Temperature Sensor-Signal / Spindle Temperature
3	V	Spindle Phase 2
4	FP	FP-Signal / Speed Sensor
5	W	Spindle Phase 3
6	SGND	Signal-Ground for Temperature Sensor-Signal
7	PE	Protective Earth

## 6.3 Spindle Connection with pluggable screw terminals used at SSE

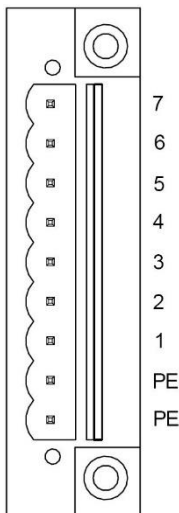

Pin	Description
PE	Protective Earth
PE	Protective Earth
1	Spindle Phase 1 (U)
2	Spindle Phase 2 (V)
3	Spindle Phase 3 (W)
4	Temperature Sensor-Signal (Spindle temperature)
5	Hall-Sensor-Signal (Spindle speed sensor)
6	SGND / GND for FP- and Temperature Sensor Signals
7	UH +15V for active hall sensor supply

## 6.4 Mains Supply

SSE 3 pin. pluggable screw terminals, 4mm<sup>2</sup>

Desktop IEC60320 C14 3 pin. mains jack for detachable mains cord

## 7. Functions, Setup, Operation

3 operational possibilities:

- ✓ Control and configuration manually via front keys
- ✓ Automatic control and configuration via PLC / IPC
- ✓ Automatic control and configuration via PC (RS232 interface)

### 7.1 View at the Front Panel



SFU 0300 DeskTop



SFU 0300 SSE

With the **START** **STOP** -key the spindle is started and stopped. The rotational speed is adjusted with the radio knob. The actual rotational speed is displayed on a 3digit LED.

The Status LEDs **READY**, **RPM 0**, **RPM OK**, **>100%** give information on the actual spindle status:

The red LED **>100%** indicates generally an error or as an indicator for an overload condition.

With firmware versions from V2.0 on the errors are displayed as an error code in the display. (see chap 7.7).

Additionally these states were signaled on the relay out outputs:

At overload relay 2 **Rotational Speed Reached** is deenergized and will be opened.

With a general error relay 3 **Ready** is deenergized and will be opened.

The errors can be evaluated with the help of the windows software *SFU-Terminal*, which is available on the website. The documentation of this software shows how evaluation of these errors is possible.

#### ATTENTION:

Where several spindles are in use within one system, the user must ensure that these are of the same type and that the correct spindle characteristic is used.

Otherwise this could cause severe damages of one or more spindles, because the driving voltage may be different!



## 7.2 Configuration of the Rotational Speed

The preset of revolutions per minute of the spindle can be achieved by three ways:

- ✓ **Preset manually** with the radio knob on the front panel
- ✓ **Preset via analogue input** Set Value Rotational Speed  
The default scaling for this input is set up to 1V/10.000rpm
- ✓ **Preset via RS232 interface**

## 7.3 Configuration of the Direction of Rotation

The direction of rotation can be set up before start. For this the key **STOP** has to be pressed approx. 4sec. In the setup mode it can be switched with the **START STOP**-keys alternating between Right and Left. Right means clockwise rotation with view to the back side of the spindle and Left means counter clockwise respectively. This is stored within the converter, so that this selection is maintained even after power off.

It will be returned to the operating mode if the keys are not pressed for a while.



## 7.4 Selection of the Spindle Characteristics

For selecting another characteristic the **STOP START** – key has to be pressed together for about 4 sec. In the selection mode, the next higher characteristic can be selected with the **START** – key and the next lower with the **STOP** – key.

Up to 16 different characteristics can be stored. In case of selecting a characteristic place where no data have been stored it will be displayed for example **E 0 3** "for missing characteristic No.3". The display stays in this state, unless a used place is selected. If a characteristic is available it will be the respective place number using **0 1** or **0 2** an so on.

It will be returned to the operating mode if the keys are not pressed for a while.

The configuration of the characteristic places can be carried out with the PC-software *SFU Terminal*.



### ATTENTION:

The operation of a spindle with a wrong characteristic may harm the spindle severely!  
Please ensure to have the proper characteristic selected always!



## 7.5 Starting and Stopping the Frequency Converter

Due to many different requirements, there are several possibilities for starting and stopping the **SFU 0300** frequency converter:

- ✓ Manually with the panel keys
- ✓ controlled remotely via a digital input
- ✓ controlled remotely via an analogue input
- ✓ controlled remotely via serial interface

In every case, with the exception of analogue start, the start of the converter is only possible, if a preset of the rotational speed is set up.

- ✓ Manually via panel keys  
Activation of spindle start via the green **START** key.  
Spindle-stop is activated by the red **STOP** key on the operator panel.
- ✓ Remote control via digital input **Start/Stop** by external PLC or CNC  
Digital Input 1 is the default. If necessary, this can be changed to another input with the help of *SFU-Terminal* software in the menu "Digital Inputs".

According to safety requirements all signals can be set up individually for ACTIVE-LO or ACTIVE-HI. In combination with a plc the configuration ACTIVE-LO is to be preferred, because in case of spindle cable defect or plc fault an automatic stop can be carried out.

- ✓ Remotely via the analogue input **Rotational Speed Duty** .  
This is possible, if the start-function is assigned to an analogue input and valid signal at the digital input **Start/Stop** is present.  
This setup can be made with the *SFU-Terminal* software in the menu "Analogue Inputs":

In the according edit-field for the preset of **Rotational Speed Duty** a selection of the scaling can be selected (for example: 1V/10.000UpM or 0-10V min/max).

An input voltage of 0V makes the spindle to stop, and a voltage higher than 0V starts the spindle to a rotational speed according to the scaling.

The above mentioned scaling makes the converter run the spindle 40.000rpm at 4V.

- ✓ Remotely via the RS232 serial interface from a PC or PLC  
The rotational speed can be changed with commands via interface. (refer to help in the menu bar of windows software *SFU-Terminal* (as option).

If necessary, a documentation of the serial interface commands can be ordered at BMR GmbH or the responsible representation.

### ATTENTION:

Where one of the above options has been selected to operate the converter, only that pre-selected option can then be used to stop the converter! Only one of the safety functions can override the operation



## 7.6 Remote-Controlled Configuration of Direction of Rotation via Digital Inputs

This can be achieved via the digital input **Direction of Rotation** . The setup can be done with *SFU-Terminal* software in the menu "Digital Inputs":

This is necessary, if the direction of rotation has to be controlled , for example, via a PLC. Reversal can only take place once the spindle / motor has come to a complete stop. If the direction pre-selection setting is changed whilst the spindle / motor is running, the spindle / motor will not turn in the new direction until it has been brought to a complete standstill and then restarted.

## 7.7 Error Codes

With firmware versions from V2.0 on, errors which lead to a switch off of the converter are displayed as error code in the display. If there are more than one errors present, the error codes are displayed sequentially.

They are coded as listed below:

- E30: Overload switch off (after delay run out)
- E31: Over-temperatur of Converter
- E32: Over-temperatur of Spindle
- E33: Over-temperatur of Converter or Spindle
- E34: DC-Link Over voltage
- E35: DC-Link Under voltage Off
- E36: DC-Link Under voltage Stop
- E37: Over-current Trip -> Power stage Off
- E38: Emergency-Stop input locked
- E39: No spindle or spindle cable defective (with activated spindle test)
- E40: TimeOut serial interface
- E41: Spindle characteristic invalid or corrupted
- E42: Error back energy -> power stage off
- E43: reserved
- E44: reserved
- E45: Error of speed sensor / encoder

## 7.8 List of errors indicated with red LED

The following errors are signalled on the red LED:

The following faults lead to an immediate stop without delay

- Overload converter
- Overvoltage intermediate circuit
- Undervoltage intermediate circuit
- Reverse energy too high

The following faults lead to a shutdown with selectable delay

- Overtemperature SFU
- Spindle overtemperature (with connected PTC and activation in characteristic curve)
- Power stage shutdown
- Emergency stop locked

The following errors are displayed after switching on

- Without spindle ( with activated spindle test)
- Characteristic error
- EEprom error

## 7.9 Safety Functions

The following safety functions bring about controlled stopping of the machine, pre-defined by the deceleration times selected within the spindle characteristics,

- ✓ Safety stop by spindle overtemperature, if this function is activated and it's delay-time exceeded.
- ✓ Safety stop by converter overtemperature and delay-time exceeded
- ✓ Safety stop by overload and time delay exceeded
- ✓ Safety stop by exceeding the maximum admissible spindle current.
- ✓ Emergency stop via digital input locking



## 8. Calibration and Configuration using Windows-Software

The setup of this device can be done in a very flexible and comfortable way with the help of our Windows PC-Software software **SFU-Terminal**. It is available on CD or on our website [www.bmr-gmbh.de/html/british/dokumente/bediensoftware.htm](http://www.bmr-gmbh.de/html/british/dokumente/bediensoftware.htm) for free. It is possible to administrate spindle characteristics or to configure the functions of inputs and outputs. Moreover there are further functions and useful tools available

Die Parametrierung des Geräts ist mit Hilfe der PC-Software **SFU-Terminal** vielseitig und komfortabel möglich. Es können Spindelkennlinien angelegt und die Einstellung der Ein- und Ausgänge konfiguriert werden, und bietet weitere Funktionen und nützliche und hilfreiche Tools.

## 9. EMC

- ✓ This unit is designed for operation in **industrial environments only**. When used in residential and commercial areas, additional measures may be required to limit the emitted interference.
- ✓ Compliance with EMC (Electro Magnetic Compatibility) limits is the responsibility of the machine or device manufacturer. The inputs and outputs of this unit are equipped with filters to increase immunity to interference and reduce emitted interference. This makes operation in an industrial environment possible in principle.
- ✓ The EMC of a machine or a device is influenced by all connected components (motor, cables, wiring, ...). Under certain conditions, it may be necessary to connect external filters to ensure compliance with the applicable EMC standards.
- ✓ For trouble-free operation and to reduce emitted interference, the following instructions should be observed when wiring:
- ✓ Make the earth and shield connections of all devices working in conjunction with the inverter as short as possible and with the largest possible cross-section.
- ✓ Connect control devices (PLC, CNC, IPC, ...) connected to the inverter to a common earth connection or busbar.
- ✓ Use toothed lock washers for mechanical installation to ensure good electrical contact with the enclosure.
- ✓ Use shielded cables for all connections to and from the inverter. Earth the screen at both ends
- ✓ Always route the mains, motor and control cables separately from each other. If crossings are unavoidable, they should be laid at a 90° angle.
- ✓ Lay the control cable as far away as possible from the load cables.

# 10. Views and Dimensions

## SFU 0300 in desktop housing with LED-Display

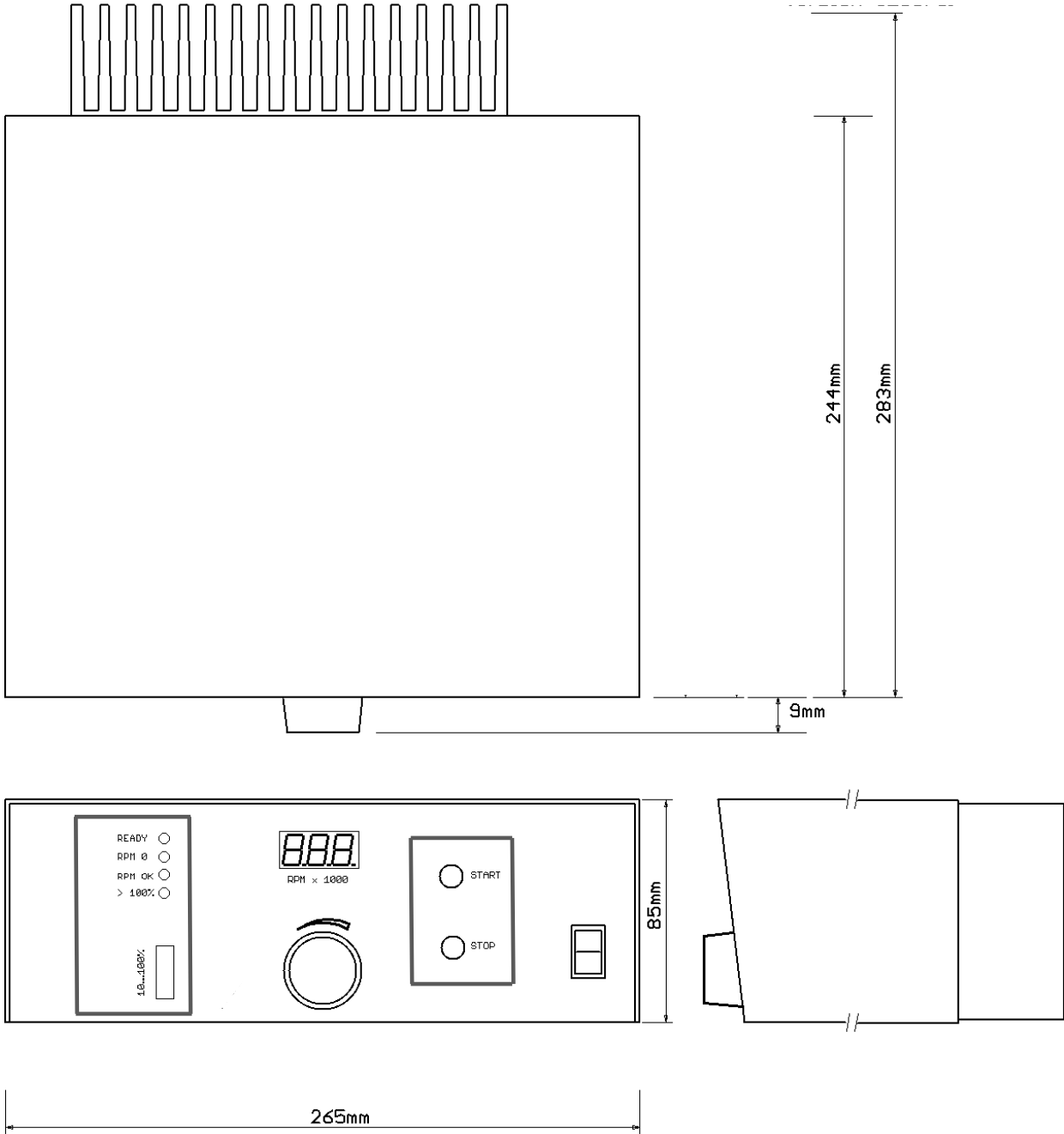

SFU 0300 in SSE Housing for cabinet mounting

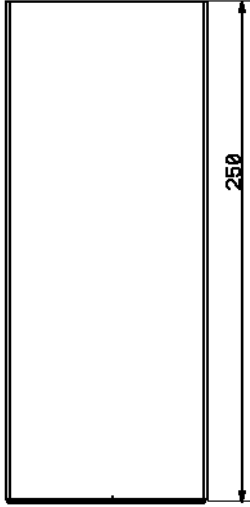

Masse in / Measures in [mm]

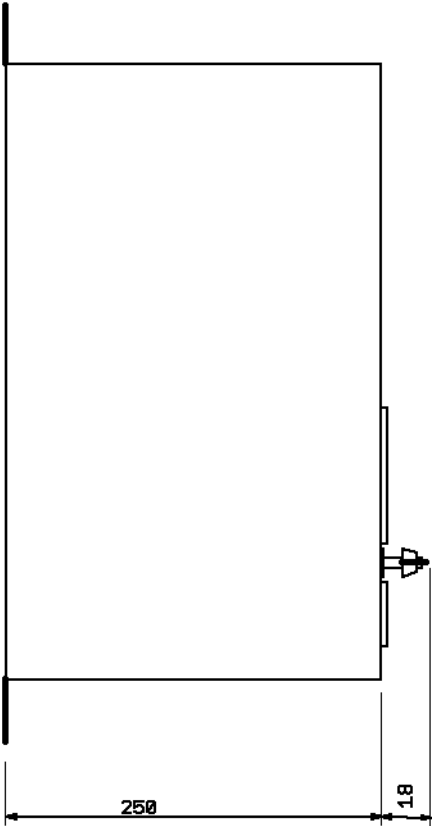
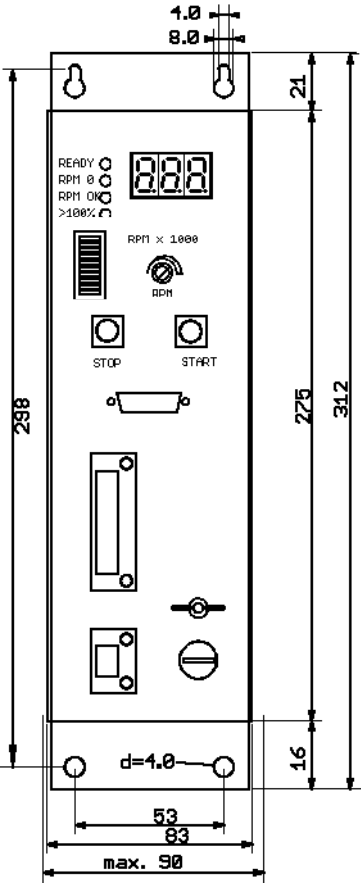

# OUR QUALITY COMMITMENT

<b>100%</b>	<b>„Made in Germany“</b>
<b>100%</b>	<b>precision</b>
<b>100%</b>	<b>reliability</b>
<b>100%</b>	<b>support</b>
<b>100%</b>	<b>flexibility</b>



**Subject to technical alterations.  
November 2021**







# CONTACT

FON 09122 / 631 48 - 0

FAX 09122 / 631 48 - 29

**BMR GmbH**

elektrischer & elektronischer Gerätebau

**Walpersdorfer Straße 38**

**91126 Schwabach**

E-Mail [info@bmr-gmbh.de](mailto:info@bmr-gmbh.de)

Homepage [www.bmr-gmbh.de](http://www.bmr-gmbh.de)



**BMR Homepage**



**Manuals**

