

The Sign of Quality
Made in Germany

SFU 0303/4

Schnellfrequenzumrichter
High Frequency Converter





HIGH QUALITY

100%

MADE IN
GERMANY



EXCELLENT SERVICE

Content

Issue Mai 2017

1	Introduction	2
2	Description and Features	4
3	Block Diagram	5
4	Technical Data	6
4.1	Version SSE	6
4.2	Version 19" and Desktop	7
5	Safety Precautions and Warnings	8
6	Connections, Interfaces and Pinout	9
6.1	Digital and Analogue Inputs and Outputs	10
6.2	Spindle Interface X4	11
6.3	Version SSE: Mains Connector, Spindle Connector	13
6.4	Version 19": Mains Connector, Spindle Connector	14
6.5	Version Desktop: Mains Connector, Spindle Connector	15
6.6	Version SSE: RS232	17
6.7	USB-Connector	17
7	Functions, Setup, Operation	18
7.1	Front panel of SSE, Desktop und 19" Version	18
7.2	Converter Start and Stop	19
7.3	Status LED Display	20
7.4	LCD-Operating Panel	21
7.5	Start and Stop	26
7.6	Setup of Rotational Speed	26
7.7	Safety Functions	26
8	Setup with Windows-Software	27
9	Automatic Spindle Tuning	28
10	Examples for Connection	30
11.1	Mains and Spindle Connection	31
11.2	Logic and Wiring for Safety	32
11	EMC	32
12	Troubleshooting	33
13	General Hints	37
14	Warranty	38
15	Accessories	39
16	Mechanics and Dimension	40
16.1	SEE Version for cabinet mounting	40
16.2	19" Version	41
16.3	Desktop Version	42
16.4	Desktop 63TE Version	43
17	Other products of BMR GmbH	44
18	Our Quality Commitment	45

1. Introduction

Due to its construction, the rotational speed of a 3-phase AC motor is directly dependent on the frequency of the voltage and the number of poles. In case of a 3PH 50Hz voltage and a 2-pole motor, the nominal speed would be $50 \text{ rps} * 60 = 3000 \text{ rpm}$.

In case of BLDC motors (brushless dc), the speed is directly dependent on the voltage applied.

3-phase AC motors provide numerous benefits in industry, such as brushless operation, freedom from wear and tear, favorable capacity/weight ratio, high-speed capability, and much more. These motors can be used many different application areas, such as milling and grinding spindles, or with drilling machinery, for example.

The advantages of SFU0303 compared to similar converters:

- ✓ Safe Power Stage Pulse inhibitor, authorized to current regulations EN 954_1 Cat 3
- ✓ Maximum Power in industrial network up to 5kVA
- ✓ High efficiency by symmetrical PWM
- ✓ Real time vector control for sensorless operation
- ✓ Maximum Torque even at lowest rotational speeds
- ✓ High possible acceleration rates for short process times. For example 25.000rpm/sec with a 2,2 KW Motor (with robotic applications)
- ✓ Pulse-Amplitude (PAM / =Block-Modus) Control possible because of regulated intermediate voltage control (on option)
- ✓ Very slow rotational speeds (10rpm) possible for reaching tool changer positions.
- ✓ Very low current consumption because of real time power control
- ✓ Easy Integration into new and existing PLCs because of flexible I/O configuration
- ✓ Various interface options: RS232, USB
- ✓ Easy reversing the direction of rotation by Software without loss of power.
- ✓ Autotuning function for spindle setup.
- ✓ Testrun with graphical documentation of voltages and currents of the spindle
- ✓ Up to 16 different spindle characteristics can be stored
- ✓ Very user-friendly debugging interface for setup control

- ✓ Start/Stop Interface for periodical tests or remote control
- ✓ Operating panel is detachable and can be used as remote control together with an extension cable
- ✓ Designed for roughest use in industrial environment
- ✓ The housing of SSE is realized without ventilations slots and an outside mounted heatsink. preventing by this the intrusion of dirt and chips of tooling.
- ✓ Very compact case style makes easy cabinet mounting possible
- ✓ Several case options for cabinet mounting (SSE) , 19" rack style and desktop, or special designs on request
- ✓ User friendly Screw-plug connector system for power-, spindle- and I/O connectors.
- ✓ Wide range of operating voltage 115V-230V
- ✓ Automatic deceleration of the spindle down to standstill in case of mains failure by "Back Energy" Function
- ✓ Plain text display in amber color
- ✓ Very user friendly operation menu.
- ✓ USB connection and RS232 with specific adapter cable
- ✓ Full functional without operation panel in remote configuration
- ✓ Remote control hand-terminal available
- ✓ Controlled fan
- ✓ Datalogger-Function on option available in combination with PC software SFU-Terminal. Records of all relevant parameters of the converter in nearly infinite lengths are possible down onto the PC- hard disc.

2. Description and Features

- ✓ Operation of **Asynchronous AC und BLDC Motors**
- ✓ The high frequency converter SFU-0303 makes possible **output frequencies 3.3 kHz / 200.000 Upm** with 2pole AC-Motors and with BLDC-Motors up to **100.000rpm**
- ✓ **High output power (3,6kV @ 230V / 2kVA @ 115V)** in **compact style**
- ✓ The core of SFU-0303 is a **Digital Signal Processor (DSP)** which produces all output signals and collects all input signals
- ✓ All parameters like current, voltage and frequency are collected in **real time** and are regulated by the implemented vector control depending on the load condition.
- ✓ **High precision sinusoidal** output signals with low distortion factor realize very high accuracy in true running behavior.
- ✓ Allows highest **efficiency** of the spindles at **low and high frequencies**
- ✓ High **operational safety**: All operating conditions like acceleration, operation with nominal rotational speed, deceleration is monitored and critical conditions are intercepted.
- ✓ **Integrated braking resistance (brake chopper)**. Without brake chopper the deceleration times down to standstill can be longer.
- ✓ **Transparency**: The user is always informed about the current status of the converter and the spindle on a plain text and detachable operating panel at the front panel.
- ✓ **Control**: If needed, the converter can be controlled and parameterized manually with a pluggable operating unit.
- ✓ Easy **reversing the direction of rotation** by Software **without loss of power**.
- ✓ **Individual adjustment** to the current application and the connected spindle. Up to 16 different characteristics can be stored in the converter
- ✓ **A variety of options for control and communication possibilities**: For communication with peripheral devices, such as PC, PLC or CNC, there are 3 ports available:
- ✓ **Easy and flexible integration** into existing equipments by free configuration of I/Os
Control inputs: 2 Analog, 6 Digital
Control Outputs: 2 Analog, 6 Digital (Relay)
- ✓ **Galvanic separation** of all interfaces from each other and from mains / spindle potential
- ✓ **Short circuit proof**
- ✓ **Comfortable Configuration** und control with the help of a PC-Windows software "SFU-Terminal"
- ✓ **Cloning-Function with operating panel**: Creating of clones of converters by individual read out of the SFU-parameters into the operation panel and download into another or multiple SFUs.
- ✓ Automatic spindle calibration by **autotuning function**

3. Block Diagram

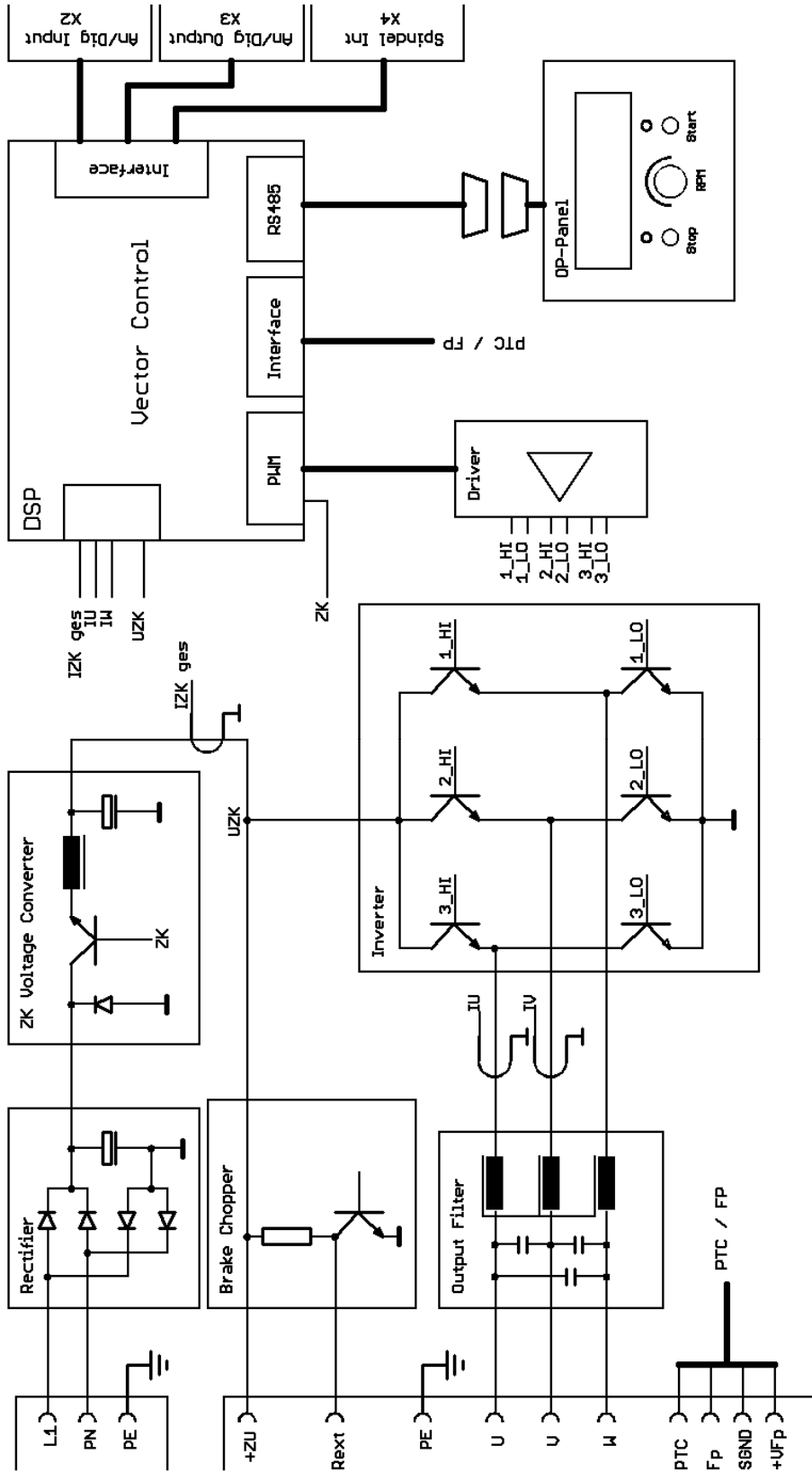

4. Technical Data

4.1 Version SSE

Mains connection	115V, 60Hz	230V, 50Hz
Continuous output power	2 kVA	3,6 kVA
Motor connection	10-polig: PE, U, V, W, PTC, FP, SGND pluggable screw terminals 4mm ²	
Output voltage	110V	220V
Output current / power	limited electronically	
Output-current	maximal duration adjustable 0 ... 20sec	
Output frequency	AC: max 2,2kHz / 200.000 rpm DC: max 1.667Hz / 100.000 rpm	
Spindle characteristics	max. 16, stored internally	
Spindle sensor inputs	PTC, Speed sensor / Hall sensor, Logic	
Control inputs	2 Analog: 0-10V, separated galvanically	
Control inputs	6 Digital: 0-24V, separated galvanically	
Control outputs	2 Analog: 0-10V, separated galvanically	
Control outputs	5 x Digital, free to be setup outputs on Relays, 24VDC/1000mA, 125VAC/500mA	
Interface	- USB on operating panel (USB-Mini) - RS232, (9 pin DSub male)	
Dimensions	see chap 17	
Weight	ca. 4 kg depending on option	
Protection	IP20	
Operating conditions	5 - 40°C / rel. Humidity of air max. 85%	



ATTENTION

The operation of a spindle with a wrong characteristic may harm the spindle severely!

Please ensure to have the proper characteristic selected always!

4.2 Version 19", Desktop and Desktop 63TE

Mains connection	115V, 60Hz	230V, 50Hz
Output power	max. 2 kVA	max. 3,6 kVA
Motor connection	13-pin: U,V,W, PTC, FP, SGND, Shield, PE circular connector	
Output voltage	110V	220V
Output current / power	limited electronically	
Output-current	maximal duration adjustable 0 ... 20sec	
Output frequency	AC: max 3,3kHz /200.000 rpm DC: max 100.000 rpm	
Spindle characteristics	max. 16, stored internally	
Spindle sensor inputs	PTC, Speed sensor / Hall sensor, Logic	
Control inputs	2 Analog: 0-10V, separated galvanically	
Control inputs	5 Digital: 0-24V, separated galvanically	
Control outputs	2 Analog: 0-10V, separated galvanically	
Control outputs	5 x Digital free to be setup output on relays, 24 VDC/1000mA, 125VAC/5000mA 25pin D-Sub female	
Interface	- USB / - RS232 to be used alternatively	
Dimensions	see chap 17	
Weight	approx. 4 kg depending on option	
Protection	IP20	
Operating conditions	5 - 40°C / rel. Humidity of air max. 85%	



ATTENTION

The operation of a spindle with a wrong characteristic may harm the spindle severely!

Please ensure to have the proper characteristic selected always!

5. Safety- Precautions and Warnings

- ✓ This device produces dangerous electrical voltages and is used for the operation of fast spinning tools. Because of their high rotational speed, it may be dangerous in case of improper handling. For this reason, only professionally trained and qualified personnel should be allowed to work with and setup this device!
- ✓ Before the first commissioning can be carried out, it should be ensured that the spindle and the tool are fixed properly, to eliminate all dangers because of uncontrolled movement of the spindle.
- ✓ Safety regulations being valid for the country where the device is used, have to be adhered to where any work is carried out on the device.
- ✓ Before the device is turned on for the first time, it should be verified, that the connected parts cannot carry out uncontrolled movements.
- ✓ The frequency converter must not be operated close to heating devices or magnets or devices generating strong magnetic fields.
- ✓ Sufficient air circulation around the converter should be ensured.
- ✓ Fluids should be prevented from intruding into the housing. If it seems to be happened, the converter has to be switched off immediately.
- ✓ The ambient air must not use aggressive, flammable or electrically conductive substances and should be as free of dust as possible.
- ✓ All repairs and maintenance on the converter and the relating accessories must be carried out by skilled personal and with powered off, only. To ensure this, the mains plug should be pulled out. In doing this, both the terms of regulations for preventing accidents and the general and national rules for mounting and safety have to be applied.
- ✓ Do not open this device while it is connected to power supply. There is danger of life! With opening this unit the period of warranty will be ended.
- ✓ All people who work with this device should be trained and instructed by their line advanced technician.



Attention:
Please verify that all power supply voltages are correct in polarity and value.



Attention:
Please ensure to have the proper characteristic selected, always!
The operation of a spindle with a wrong characteristic may harm the spindle severely!



Attention:
In case of replacing the fuses, please ensure to use types only, which are mentioned in 'Technical Data'!

6. Connections, Interfaces and Pinouts

For embedding into PLC and controls the SFU0303 has several input and outputs. They are realized as pluggable screw terminals and are located at the front or rear panel (depending on case option). All contacts are separated galvanically from high voltage carrying circuits.

Operational parameters and outputs:

The **SFU-0303** captures all current important operational parameters and operating data. Up to 6 digital outputs can be used for signaling and up to 2 analogue values can be output to the analogue outputs (0-10V).

Remote Control and Outputs:

6 digital inputs (24V) and 2 analogue inputs (0-10V) are available for remote control of the **SFU-0303**.

These assignments can be configured freely. By using the optional Windows PC software "**SFU-Terminal**" the above mentioned assignments can be achieved easily, providing exceptional flexibility with each application.

Each operating parameter can be assigned as a signal and each control signal can be assigned to a certain I/O pin. In addition, the logic level (high or low active) can be individually defined. The same assignment is also possible for the analogue measured data and control data at the analogue I/O pin.

The standard allocations of operational parameters, their outputs, control signals and inputs, are listed in the following tables.

6.1 Digital and Analog Inputs and Outputs (25 pin D-Sub female)

Version SSE on front panel

19", Desktop, Desktop 63TE on back panel

Pin	Description	Direction	Function / Default
1	Relay Common		Common Rail relay 1-5
9	Relay 5 normally closed	Output	Standstill Converter + Spindle
2	Relay 2 normally open	Output	Duty Speed Reached
10	Relais 4 normally closed	Output	Overload > 100%
3	Relais 3 normally closed	Output	Overtemperatur
11	Analog In 1	Input	Duty Speed Input
4	Analog Out2	Output	depending on the ype of device: - DC Out current speed of spindle 1V/10.000rpm - DC Out output load 0...12V = 0...120%
12	Analog Out 1	Output	Ref. Value Duty Speed Output
5	Digital In 1	Input	Inversion of Direction of Rotation DRU high active
13	RS232 RxD	Input	
6	Relais 1 normally open	Output	Ready / Converter Ready
14	RS232 TxD	Output	
7	Hall Sensor	Output	Processed rectangular signal of speed sensorr
15	Digital In 2	Input	Emergency Stop / Converter Locking

6.2 Version SSE: Mains and Spindle connection

Pin	Name	Direction	Function
1	+VFP	Output	Auxiliary voltage supply for active speed sensor 12V/50mA
2	SGND		Ground reference for signals FP, PTC
3	FP	Input	Input for 2/3-wire speed sensors / Hall sensor
4	PTC	Input	temperture signal of the spindle or as option KTY setting via interface X4-Pin3 -> 6.3
5	W	Output	Spindle Phase W
6	V	Output	Spindle Phase V X4
7	U	Output	Spindle Phase U
8	Rext	Output	External Brake resistor / Chooper Resistor
9	+ZU	Output	Intermediate voltage (! Attention, High Tension!)
10	PE	Output	Connection for protective earth of spindle ! Safety !

Name	Function
PE	protective Earth ! Safety
N	Null
L	Phase

View at screw terminals at version SSE:

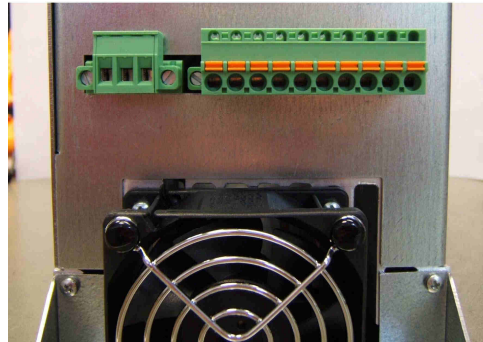

The device has no internal fusing. It has to be fused externally



Please ensure, that PE protective earth is connected at the mains side. The device must not be operated without properly connected PE!



Please ensure, that PE protective earth is connected at the spindle side as well as at the mains side.



Control wires, Mains cables and spindle cables should be installed separately.
For wiring, the use of shielded cables is recommended.

6.3 19" Version: Mains and Spindle connection

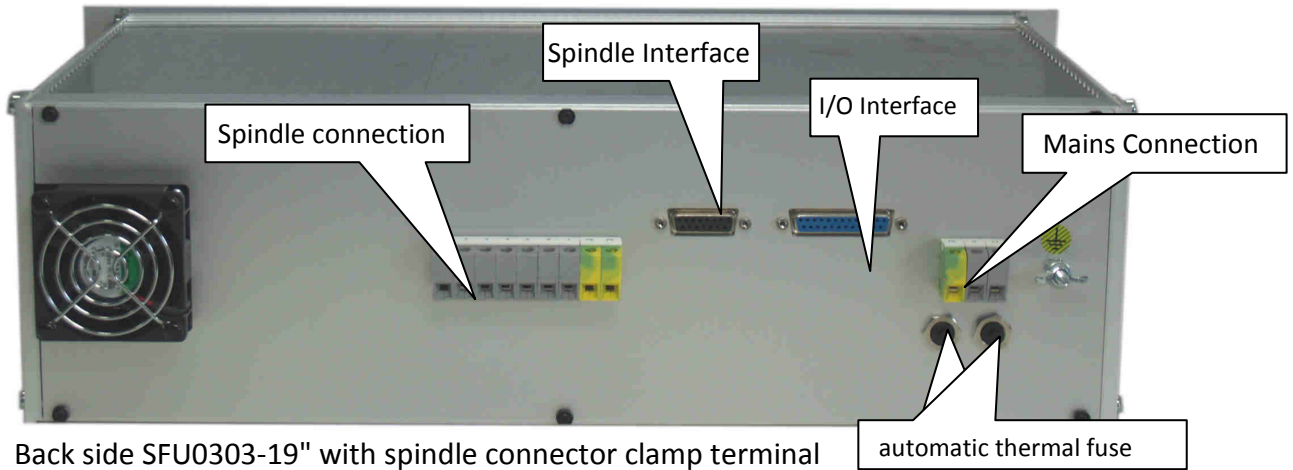

Spindle Connector - 9pin clamp terminal



Pin	Name	Direction	Function
1	+VFP	Output	Auxiliary voltage supply for active speed sensor 12V/50mA
2	SGND		Ground for signals FP, PTC
3	FP	Input	Input for two/three wire-speed sensors
4	PTC/KTY	Input	Temperature signal from spindle or as option KTY setting on spindle interface Pin1 ->6.6
5	W	Output	Spindle Phase W
6	V	Output	Spindle Phase V
7	U	Output	Spindle Phase U
PE	PE	Connection for protective earth of the spindle ! Safety !	
PE	PE		

Mains connection - 3pin clamp terminal:

Name	Function
PE	protective earth ! Safety !
N	Neutral
L	Phase



Please ensure, that PE protective earth is connected at the mains side. The device must not be operated without properly connected PE!



Please ensure, that PE protective earth is connected at the spindle side as well as at the mains side.



Control wires, Mains cables and spindle cables should be installed separately. For wiring, the use of shielded cables is recommended.

6.8 Desktop Version: Mains and Spindle Connection

The connection with mains network is carried out with an IEC connector
The device is equipped with a Thermo-Automatic Fuse for each prong. They can be reset after tripping by pressing down the button

The spindle connection is realized on custom order and can be realized accordingly

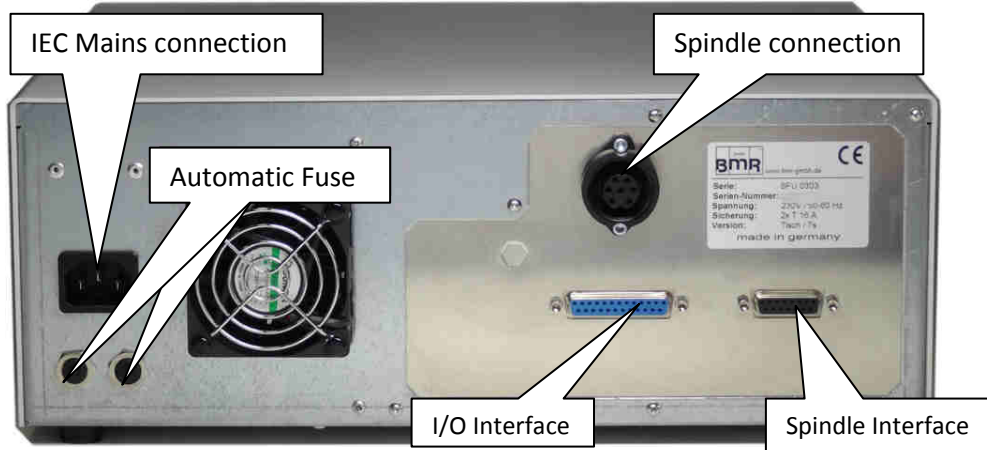

Backside SFU0303-Desktop equipped with a 7pin circular spindle connection

Spindle Connection

7pin female Binder Series 693 or Amphenol C16-1

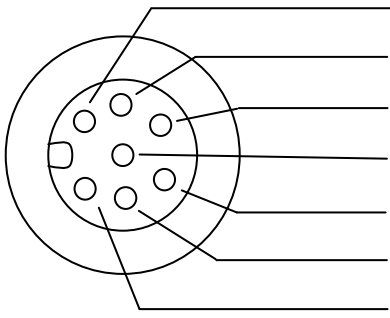

Pin	Name	Description
6	SGND	Signal GND for PTC-and FP Signal
5	W	Spindle Phase 3
4	FP	speed sensor of the spindle
7	PE	Protective Earth
3	V	Spindle Phase 2
2	PTC	temperature sensor of the spindle
1	U	Spindle Phase 1

Spindle Connection

13pin female Binder Series 694

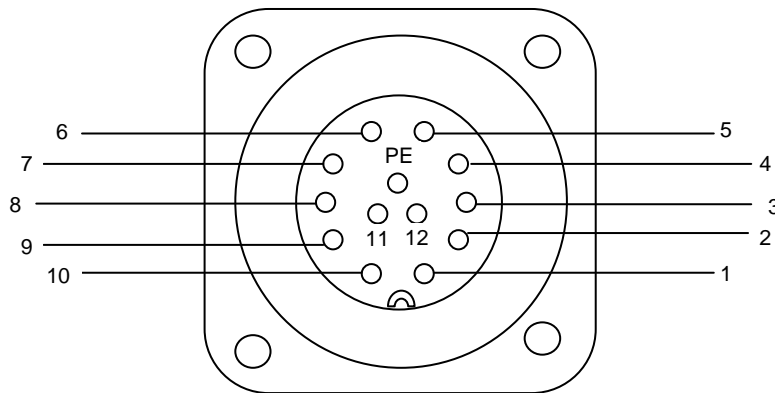

Pin	Name	Description
PE	PE	Protective Earth
1	U	SpindlePhase 1
2	V	Spindle Phase 2
3	W	Spindle Phase 3
4		NC
5	SGND	Signal Ground Speed Sensor, PTC
6	FP	Speed Sensor of the spindle
7	PTC	Temperature Sensor of the spindle
8		Shielding Control Wire 2x
9		Shielding all
10	UH	Auxillary Voltage +12V/40mA
11		NC
12		NC



Control wires, Mains cables and spindle cables should be installed separately.

For wiring, the use of shielded cables is recommended.

6. USB-Connection

For easy connection and communication, the device is equipped with a USB interface. At the version SSE it is located at the bottom side as USB Mini AB. At the 19" and Desktop devices, it is found at the front panel directly below the display.

This interface shares the functionality with the USB Interface. For that reason it can be used **alternatively**, only



7. Functions, Commissioning, Operation

7.1 Front panel SSE, Desktop and 19" Version



front panel SSE



front panel Desktop



front panel Desktop 63TE



front panel 19" version

7.2 Spindle Characteristics and Starting the Converter

Spindle Characteristics

All converters of BMR need an information about the basic data of the spindle, such as maximum voltage, current, rotational speed, and many more. These are stored in so called "spindle characteristics". A BMR spindle characteristic has 16 setpoints within the range of the rotational speed. At every point data of voltage, current, load scaling, acceleration and deceleration ramp and many more data can be defined and this for idle load as well as for full load. And there are in total 16 places for different characteristics. The spindle characteristics are the key for any spindle and give a possibility to control the running behavior at every load condition.

In advance of start of a spindle first, it has to be ensured, that the proper characteristic is selected and activated. This is generally the case if the device is delivered together with a spindle and the required setup is done. If the converter and spindle are delivered separately, the proper spindle characteristic has to be loaded into the converter first. This can be achieved with the free setup software SFU-Terminal, easily.

In case of being unsure, characteristics for most common spindles are available at BMR.

The spindle characteristics can be defined either in the project file (* .ps5) or via a setting in the operating panel (-> 7.4 Setup) . Furthermore, with the activation of the remote control interface is X4 (6.3 / 6.6) a control via the digital inputs Bit1 ... Bit4 to X4 possible. The setting in the project file or via the operator panel is then ineffective, however.

Spindle characteristics are created by BMR and can be loaded and managed using the SFU - Terminal .

Start and Stop

There are several possibilities for starting and stopping a spindle, due to many different requirements, as follows below:

Generally, a STOP can be triggered by the source of START, only, with the exception of an Emergency Stop, activated power stage pulse locking or any other safety function.

- ✓ Start button at operating panel, Rotational speed with encoder potentiometer
- ✓ Serial control with commands via RS232 / USB interface
- ✓ Digital input in combination with an activated analogue input for control of rotational speed. In case of not being activated, the rotational speed is setup with encoder potentiometer at the operating panel or via serial commands.

Status display

The current status of the converter is displayed on the status LED display and with mounted operating panel the status is displayed in plaintext on the LCD-display, additionally.

7.3 Status LED Display at SSE

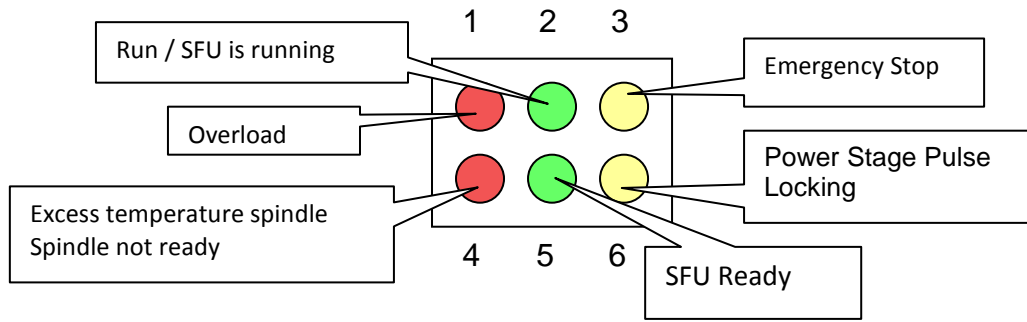

Typical displays. Other combinations are possible due to status.

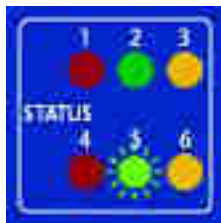

Ready + Standstill
Converter and Spindle ready



Converter OK,
and Spindle is running
Overload

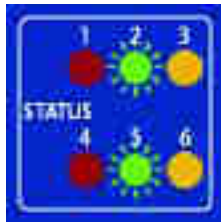

Converter OK,
Spindel running



Emergency Stop
and/or Locked

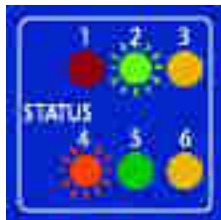

Spindle running Excess
temperature at Converter

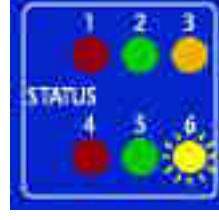

Power Stage Pulse Lock active

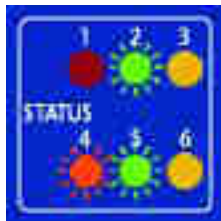

Converter ready
Spindle running,
Excess temperature at Spindle

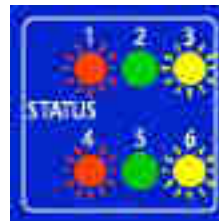

Ground fault

A Start is possible, if the display shows "Ready+Standstill - Converter and Spindle ready". There are different means for solving errors which are listed in Chap "Troubleshooting". The most probable reason for problems is a not properly wired input for "Emergency Stop" or "Intermediate Lock". In this case it is recommended, to check the setting in the menu "Digital Inputs" in SFU-Terminal

7.4 LCD-Operating Panel

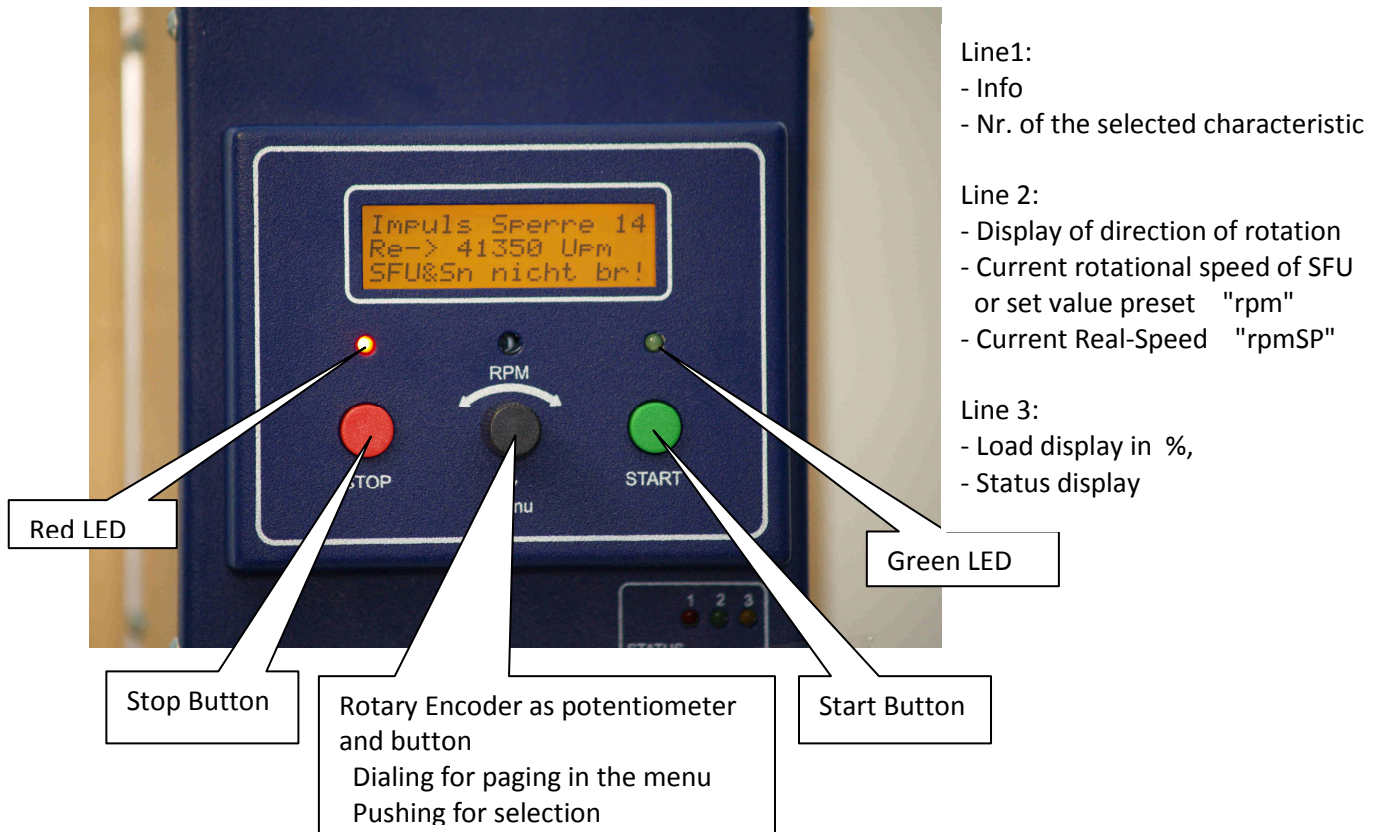

Operating Elements:

Start-Button

For Starting the Spindle

Stop-Button

For Stop of Spindle or ending the Menu function

Encoder Potentiometer und Menu-Button with multifunction

During standstill and run mode the set value for speed can be setup by dialing
Short pushing during run mode switches on the debug mode.

Long pushing during standstill opens the setup menu

Dialing selects the menu item and
Short pushing selects the function.

Automatic ending of the menu after 10sec without manipulation or

short pushing of the Stop-Button

LED green

for indication of *Ready for Operation* or of *Run mode und Spindle is spinning*

LED red

for indication of *Standstill* or of *Stop mode or Error*

Start and Stop at the operating panel

In the simplest case, a connected and appropriately set up spindle can be started by pressing the Start-Button. The desired speed can be adjusted by dialing with the rotary encoder either as preset value during standstill or in Run mode. The preconditions for a correct Start can be looked up under 7.1 and 7.5 .

Any error or malfunction is displayed as plain text

All relevant system messages on rotational speed, load or problems are displayed on the LCD display

The current power output is displayed in the lower part as analogue load bar as % and absolute.

An overload condition will be displayed as well.

The pre selected speed, the selected characteristic and current speed are displayed



Attention:

The operation of a spindle with an incorrect spindle characteristic may harm the spindle severely!

Please ensure that the correct characteristic is selected



If several spindles are operated simultaneously, it has to be ensured that they are of the same type and that a specific characteristic is selected. Otherwise this may harm one or more spindles or the converter severely!

Setup-Menu:

To enter the menu, the Menu-Button in the rotary encoder should be kept pressed for more than 1sec. After that and releasing the button the following menu items can be selected by dialing.

✓	Direction of Rotation	CW/CCW
✓	Selection of spindle characteristic	Characteristics 1..16 are displayed
✓	Debug Mode	Display of Mains voltage, current and spindle voltage for 30sec
✓	Firmware Version	Current Version Nr. at line2 for 5sec
✓	Language	Selection of display language: German, English, French
✓	Contrast	Adjusting the contrast
✓	Read Config	Read out the SFU project data into the operating-panel (→ Cloning)
✓	Write Config	Download of stored project data into the SFU (→ Cloning)
✓	ESC	Quit menu

With the rotary encoder a menu item can be selected which will flash if it is active.

By pushing the Menu-Button, the current item or the final entry is selected.

With ESC or pressing the Stop-Button or after approx. 10sec without activity the menu is quit without changes. The display returns to standard operating mode.

The adjustment of direction of rotation and the selection of the characteristic are possible during standstill, only.

In case of activating the menu during run mode, the spindle will be stopped after 5sec. for safety reasons.

Attention: Selecting the function Write Config the currently stored project data of the SFU will be overwritten without warning. By this a cloning of several SFUs can be carried out easily. Please verify, if this is really intended and if there are loaded proper project data into the memory by a previously Read Config operation.

Characteristic 3 is selected
preset speed 25.000rpm
Standstill

```
Standstill !      3
CW →  25000 rpm
Conv&Spin ready !
```

Converter is accelerating
Power output 67%

```
Outp.  7830 rpm      3
■■■■■■  67%
```

Spindle is running at set value duty speed
Power output 20%

```
Duty speed OK  3
CW →  25000 rpm
■■  20%
```

Any error is displayed in plaintext in line 1

```
Overload      3
Outp.  25000 rpm
Conv.not ready !
```

Error Messages:

The following error displays are possible:

Display	Error
Pulse blocking !	Power stage lock active
Overload Stop	Overload stop!
Overtemp. Conv.	Excess Temperature Converter
Overtemp. Spindle	Excess Temperature Spindle
Overvoltage trip	Mains voltage too high
Undervoltage trip	Mains voltage too low
Undervoltage stop	Mains voltage too low
Pwr stage off!	output stage switched off
Emgcy stp active	Emergency input engaged
No spindle !	Without spindle or cable defect
RS232 Error !	Timeout serial interface
Diagram Error !	Invalid characteristic
EncoderError !	Error with speed sensor / hall sensor
Back engy trip	Error Power Stage switch off because of deceleration ramp to high
GND fault !	Error PE is connected with a spindle line or converter is defective

Adjustments:

Set up the rotational speed:

dialing right or left with rotary encoder pot. Current value is displayed steadily. This can be the setup value before start or the current value during run.

Start/Stop:

with Start/Stop button. If the operating unit is removed during the start process the converter automatically turns into stop condition.

Debug Mode

During operation the debug mode can be entered by shortly pressing on the Menu-Button. It will be displayed the rectified mains voltage, spindle current and spindle voltage.

After 30sec of inactivity it will be returned to the standard mode, automatically.

With an additional pressing the debug mode is ended and it will be returned to the normal mode, but with displaying of the real spindle speed in place of the set value of the converter speed. This is indicated with "rpmSP". This persists permanently unless a further pressing of Menu-Button, which will return to the display of set value of the converter speed ("rpm")



Cloning

With the menu-item "Read Config" the configuration of a converter can be read out into and stored within the non volatile EEPROM memory of the operating panel. By swapping this panel to another converter this configuration can be copied into this converter with the menu item "Write Config". This is a very easy method to copy one configuration to many other converters (cloning) without any PC. But it has to be taken care that, this is not carried out without having read out any configuration before, because transferring an empty or corrupted configuration into the converter, will cause severe problems!

Vario load

is a variable limit value based on the load current , which can be in the SFU - Terminal in the " Analog inputs " activated and adjusted .

In " Digital outputs " menu function can be linked to a relay .

Once this value is reached, the relay is switched.

This makes it possible , when it exceeds the value e.g. perform a broken tool detection or detect an obtuse nascent tool for shorter stays .

7.5 Start / Stop

There are several possibilities to start the spindle:

digitally with a digital control signal at digital input1 **Start/Stop**

The switching levels for "OFF=0" are 0...7V and for "ON=1" 18...24V,

voltages between 7V and 18V are undefined.

➔ As soon as this is initiated, the spindle will be accelerated up to the set value of the rotational speed. This value can be setup as voltage at the specified analogue input which is defined in SFU-Terminal for **Set Value of Rotational Speed**. Typically this is Analog In 1.

analogue with applying a voltage at analogue input1 **Set Value of Rotational Speed**.

Precondition is a valid "ON" signal at digital input1 **Start/Stop**

➔ An input voltage of 0V makes the spindle stop, and a voltage higher than 0,29V starts the spindle up to a rotational speed according to the scaling.

Manual Start at the operating panel and speed setting with potentiometer

serial command on RS232 or USB

7.6 Adjustment or rotational speed

The preset of the rotational speed can be achieved by two ways:

- ✓ **manually preset with menu keys**
For this, the Option-Button in the line **Duty speed** in the grey field in the menu "**Analogue-Inputs**" of SFU Terminal Software has to be activated. By this all analogue inputs were switched to inactive and no analogue signal is selected for Start.
The set value for rotational speed is displayed at the LCD-Display and can be adjusted with the rotary encoder. The speed of change is dependent on the speed of dialing. The rotational speed can altered during operation, also.
- ✓ **preselection with a voltage applied to the analogue input **SetValue Rotational speed****
For this, an analogue input has to be assigned to this function, which can be done in SFU Terminal Software in the menu "**Analogue-Inputs**". Additionally it has to be selected a scaling for the analogue voltage in the listbox field at left. 3 scalings are possible: 1V/10.000rpm or 1V/1.000rpm or 0-10V min/max).
The value of the rotational speed according the scaling is displayed on the LCD-display and can be altered as wanted.
An input voltage of 0V leads to Standstill and a voltage > min voltage will make the spindle start up to the speed according to the current scaling.
A scaling 1V/10.000 and a voltage of 4V will cause a speed of 40.000 rpm.

All settings made in SFU-Terminal have to downloaded into the SFU before they are valid with the button .

7.7 Safety functions

The below mentioned adjustments refer to settings made in SFU-Terminal

The following incidents lead to a **controlled braking and decelerating** to standstill of the spindle according to its acceleration times defined in the spindle characteristic.

- ✓ Stop because of **excess temperature at the spindle**, in case this function is activated and if its corresponding delay time is exceeded, which can be adjusted in the menu "Delays..excess temperature spindle"

In the "Spindle characteristic" this function can be activated with the Check-Button Temp.
sensor and according delay time can be setup in the menu "Delays"

- ✓ Stop because of **excess temperature of the converter**, in case this function is activated and if its corresponding delay time is exceeded, which can be adjusted in the menu "Delays..excess temperature converter"
- ✓ Stop because of **overload** and if its corresponding delay time is exceeded, which can be adjusted in the menu "Delays..overload" The limit values for overload are determined in the spindle characteristic. Generally for S1 operation the current value will be 100% and overload condition is about 10% more and for S6 operation about 30% more. The default delay value is 20sec.
- ✓ Immediate stop because of **exceeding the maximum admissible current** of the converter
- ✓ **Emergency Stop** because of a valid signal at input Emergency Stop setup in menu "digital inputs"

The following incidents lead to a shut off of the output stage. the spindle will not be braked and will decelerated by its internal losses and friction. This can take quite a long time until standstill depending on its rotary mass. For a safe detection of standstill a speed sensor would be recommended.

- ✓ Stop because of **short circuit** at spindle connector. The value is defined by internal limits.
- ✓ Stop because of signal at digital input Power Stage Off setup in menu "digital inputs" A restart can only be achieved with a systematic Stop/Start-Sequence or with a valid signal at the input "Error Reset". This can be setup in the menu "digital inputs" the power stage will be activated again after 4 sec.

8. Setup, Parameterization and Configuration with SFU-Terminal

The software SFU-Terminal is a tool for the configuration of BMR frequency converters of the series SFU0102....SFU0601. Moreover it offers the possibility to read out system data and to modify them. To achieve this, the following steps should be taken:

1. Install the setup file according the installation software.
2. Power On the converter and establish the connection via USB / RS232.
3. Launch the program *SFUTerminal.EXE*
4. If the connection is established correctly, the program detects the converter automatically. In this case, the firmware of the converter is displayed in SFU-Terminal.
5. By click on **Start** it will at first carried out an upload of all parameters of the converter, a so called "project".
6. The program can be started "Offline" without a connected converter, too. The required converter can be selected manually from a list.

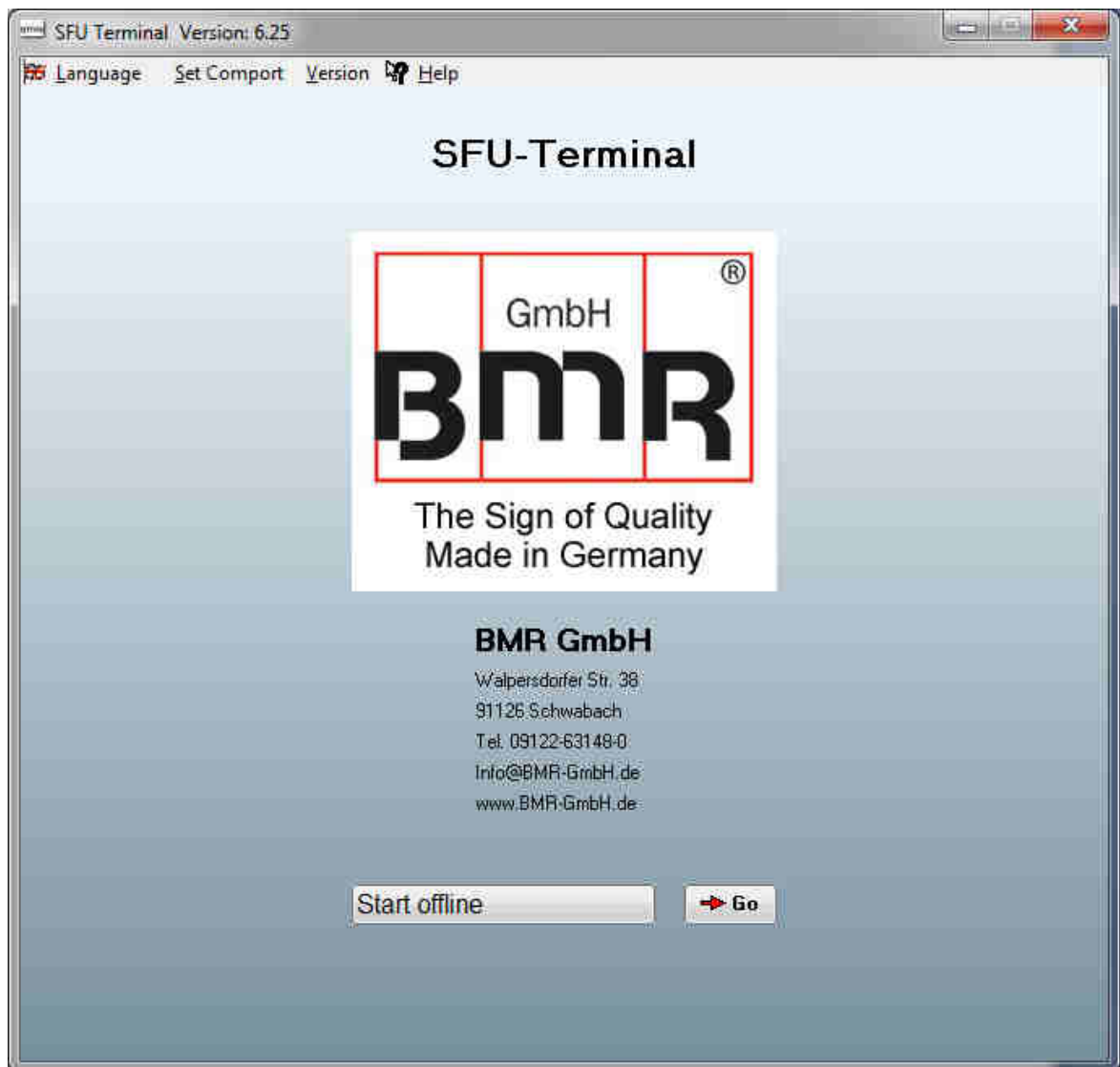

More information in Help

10. Automatic Spindle Tuning and Calibration (Autotuning)

If a motor without having a spindle characteristic has to be operated with SFU0303, it can be created very simple with the help of this tool in SFU-Terminal. The spindle is connected with the converter and the converter is connected with a PC and in the menu "Tools" the tool "Automatic Diagram" is started.

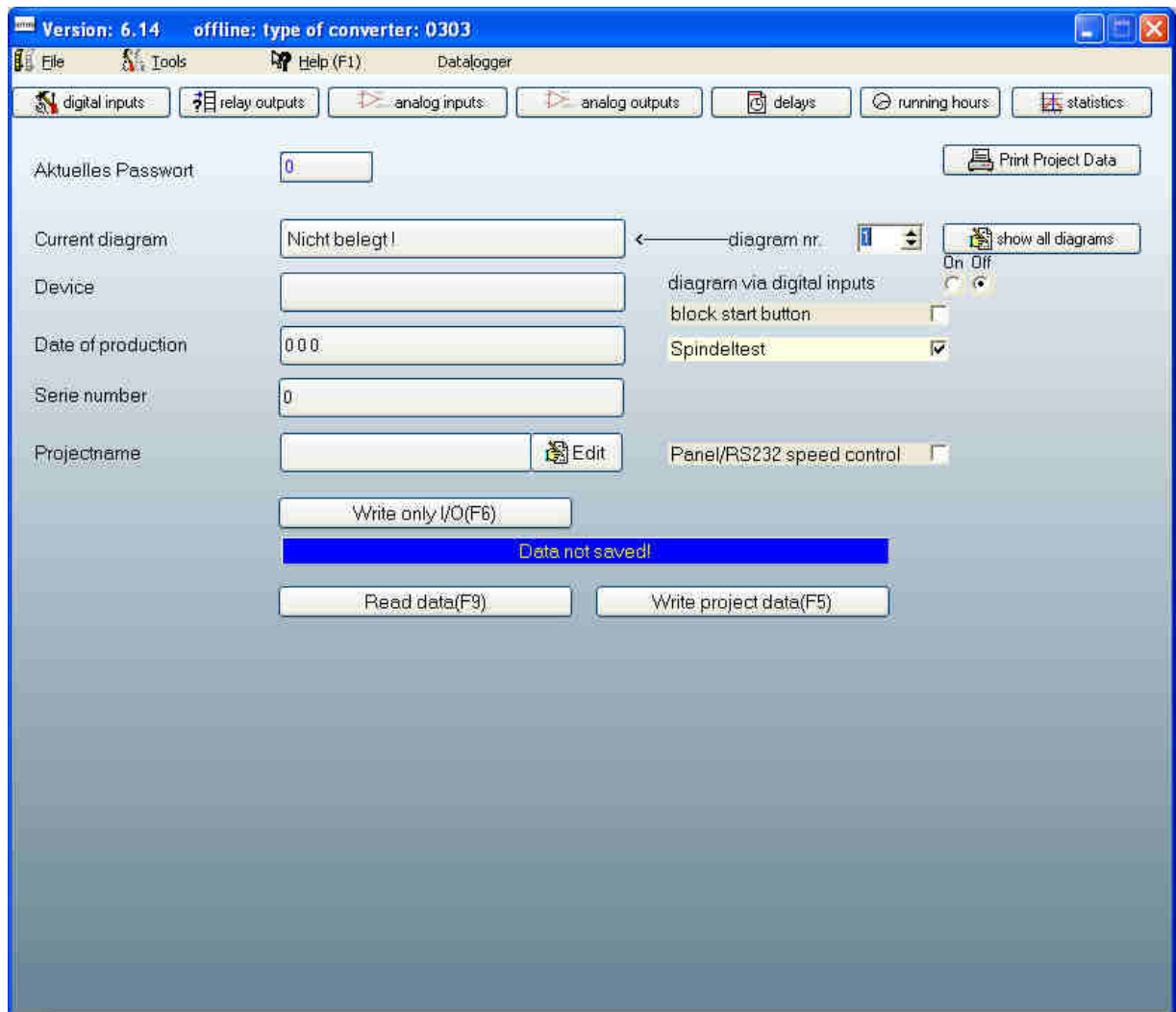

Simply the basic data of the spindle have to be input. Important is to mention the nominal voltage according to the proper speed value. The reason for this is, that AC-motors can be operated in a weakened field mode, also, which makes possible a higher rotational speed but with reduced power.

Example 1, normal adjustment:

A 2-pole motor with a maximum rotational speed of 30.000rpm needs at this point a nominal voltage of 220V at a current of 5A .

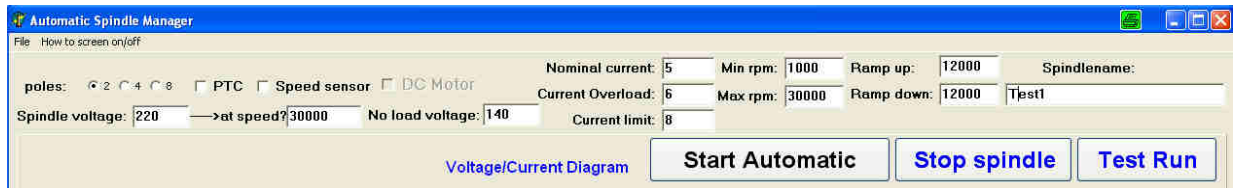

Example 2, weakened field, field suppression:

A 2-pole motor with a maximum rotational speed of 30.000rpm needs at 20.000rpm a nominal voltage of 220V at a current of 5A . But the voltage cannot be raised further, so the desired speed can be achieved but with reduced power.

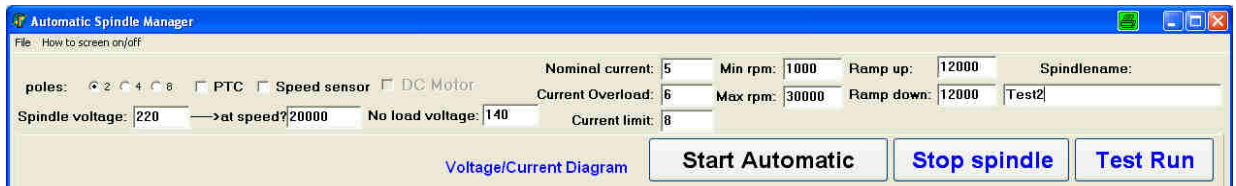

The current limit, in this case 8A, indicates the S6 mode, where it is 5A as the nominal current for the S1 mode.

The acceleration values (Ramp up/down) should be setup to be 12000rpm/sec. It has to be ensured that the shaft can rotate freely.

Start the automatic and save the characteristic after having finished the procedure. Download it into the converter.



Caution:

If using this autotuning, damages at spindles or the converter are part of warranty, due to possible wrong input values.

10. Examples of Connection

10.1 Mains and Spindle connection

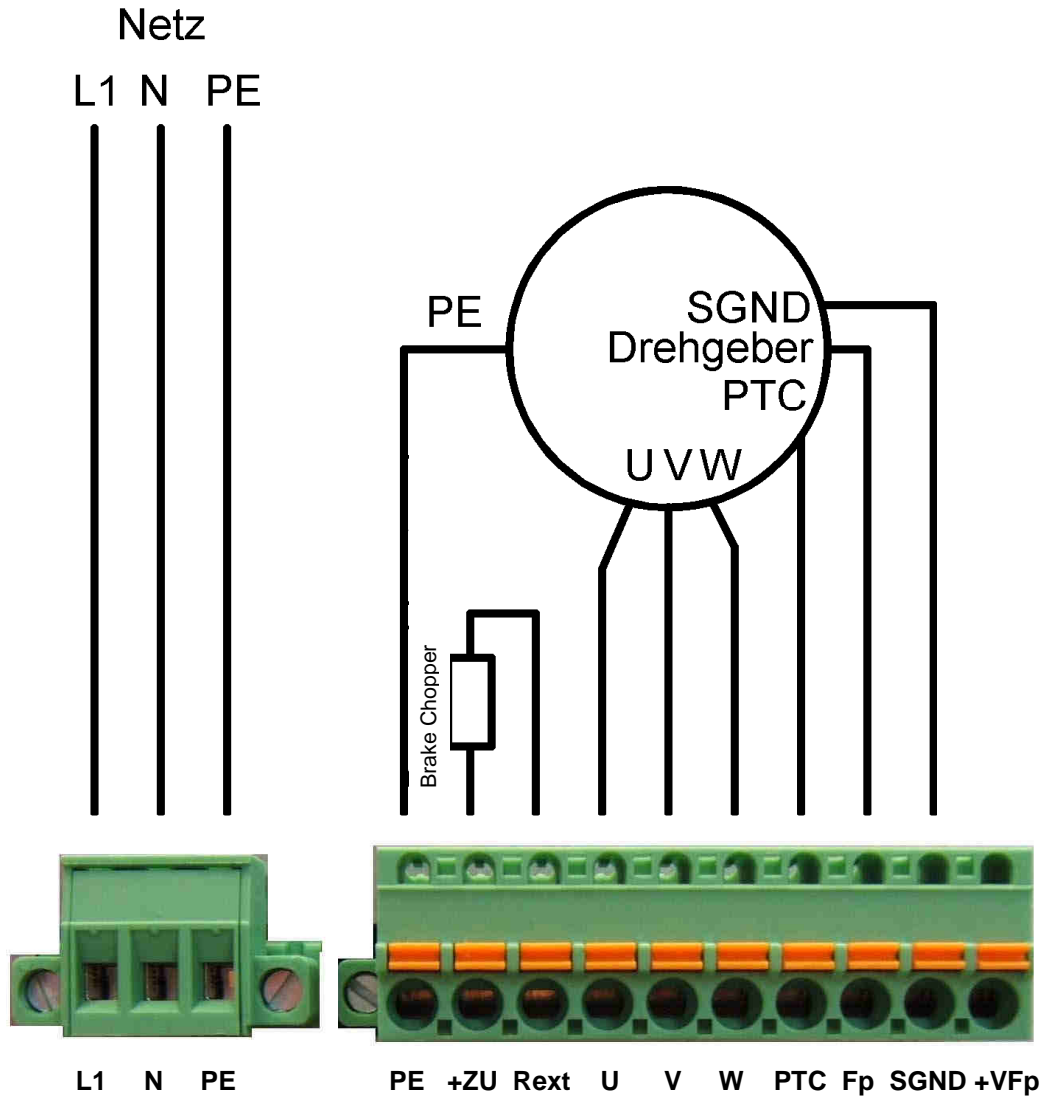

10.2 Example for Logic and Wiring for Safety Circuit

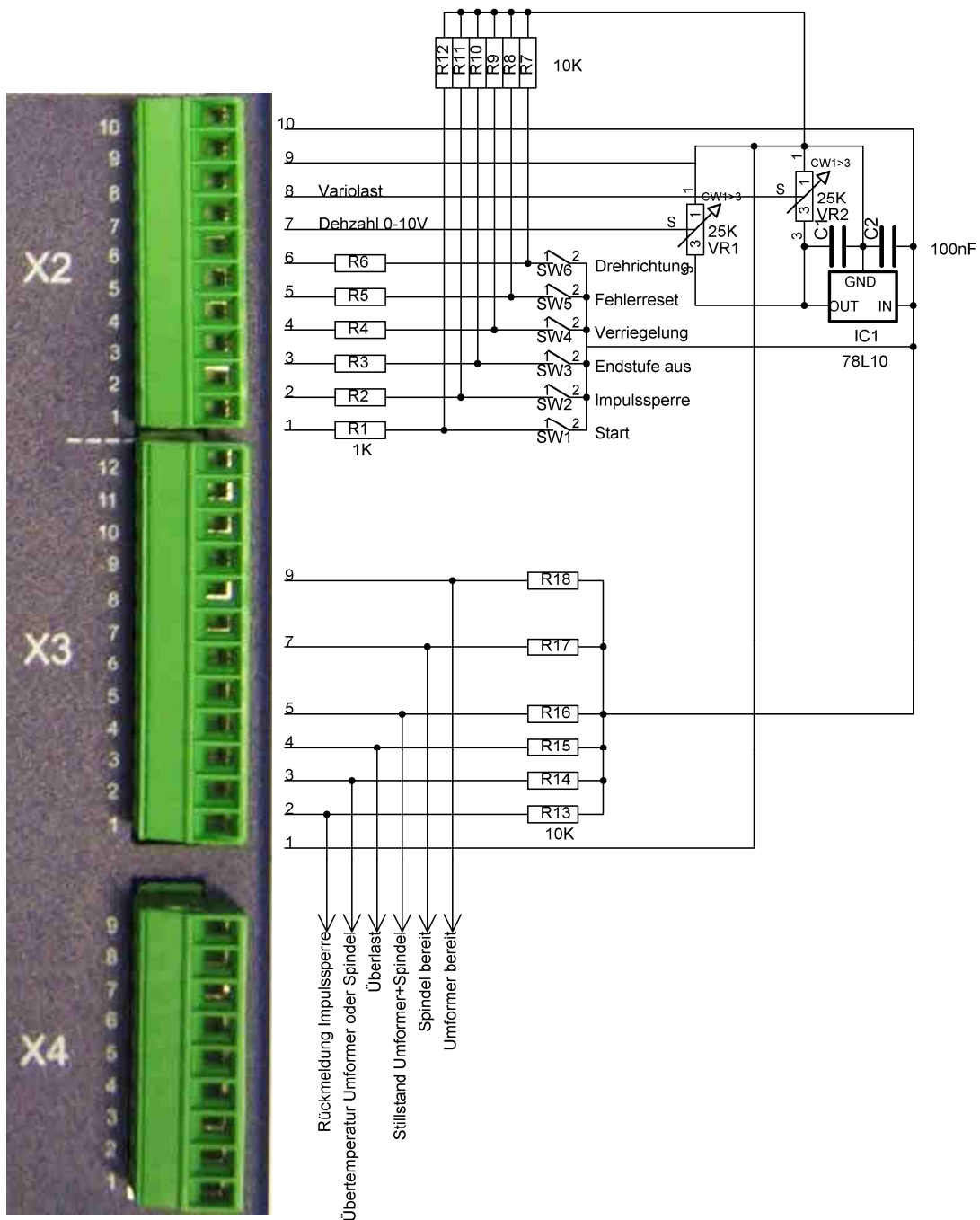

The spindle interface X4 isn't wired, because the use is depending strongly on the configuration of the spindle and the according its specific characteristic.

This interface in combination with an automatic spindle detection should be used only after consultation with BMR.

By assigning the four address lines the spindle characteristic can be selected by a PLC or external switches, in case it has been enabled

The digital wiring can even be achieved with outputs of logic circuits, with a High Out level > 20V.

The picture shows a configuration with passive switches in combination with the auxiliary voltage of the converter.

For stabilizing the reference analogue voltage for the duty speed a voltage regulator 7810 is used. In combination with a PLC generally a D/A-converter with 10V output level is used

The outputs are executed in such a way that the logic levels 0V and +24V are generated by the galvanically separated relays. For any other arrangement, the relay contacts can be wired and used freely. In the arrangement shown above, the logic level is assigned to the GND of the converter. The outputs shown in the diagram can be used directly as feed into a PLC.

Description of the behaviour during Start with released analogue input: Scaling:0-10V/MinMax

Enabling via input "digital start" – the spindle starts as soon as the level at the analogue input "duty speed" is higher than the minimum rotational speed limit being setup in spindle characteristic. It will stop, as soon as either "digital start" is low or the level at analogue input "duty speed" is below the minimum rotational speed limit.

In case of applying 10V to "analogue input "duty speed" and 16V to "digital start", the spindle will accelerate up to maximum speed.

11. EMC

The compliance with the limit values of EMC is the responsibility of the manufacturer of the machine or device.

This device was developed for use in industrial environments. For trouble-free operation and to reduce emitted interference, the following should be observed during wiring of the equipment:

- ✓ The EMC of a machine or device is affected by all connected components (motor spindle, length and type of cables, wiring, etc..). Under certain conditions the use of additional filters can be necessary to maintain the current laws.
- ✓ The earth and shield connections of all those devices used in conjunction with the frequency converter should be as short as possible and have as large a cross-section as possible.
- ✓ Control devices used with the frequency converter (PLC, CNC, IPC, ...) should be connected to a common earth/earth terminal bar
- ✓ All connections both to and from the frequency converter should be via shielded cable.
- ✓ Supply cables, motor cables and control cables must be completely isolated from each other. Where crossing cannot be avoided, cables should be laid at 90° to each other.
- ✓ The control cable should be laid as far away as possible from the load cable.

12. Troubleshooting

Error Description	Cause	Fixing
After power on the converter indicates Not Ready and Error	Input "Emergency Stop" is not properly or not wired at all.	+24Signal at this input
	The converter is at excess temperature	<ul style="list-style-type: none"> > Let the converter cool down > Check, if the fan is working properly or maintain that air flow around the heatsink is sufficient > Slow down the tooling process
	Pulse inhibitor circuit is engaged, at devices with such a circuit (SFU0303)	<ul style="list-style-type: none"> > For disengaging wire +24V to the appropriate Pin > Wire a bridge between X2.1 - X2.10 (SFU0303)
	A spindle diagram which is not valid is selected	Change spindle characteristic with the help of the front panel keys or with SFU-Terminal
	Short circuit detection of the output has tripped	<ul style="list-style-type: none"> > Check, if the spindle is blocked > Check, if there is a short circuit within the spindle > Check, if there is a Ground fault (at least one prng of the spindle cable is connected with PE) > Check, if there is a short circuit within the spindle cable
After power on the converter indicates Not Ready and Error and the evaluation of the temperature sensor is activated in the spindle characteristic	No spindle connected	Connect spindle
	No temperature sensor present within the spindle	Disable in spindle characteristic menu in SFU-Terminal the Temperature Sensor button
	Temperature sensor of the spindle defective	<ul style="list-style-type: none"> > Change spindle > Disable in SFU-Terminal in spindle characteristic menu the Temperature Sensor button

Error Description	Cause	Fixing
In case of connecting the converter with a PC or after launching the SW SFU-Terminal the Converter is not detected and not recognized	Incorrect connection cable or wiring fault	<ul style="list-style-type: none"> > Check cable for proper Pinout. > Verify at USB cables that it's length is not longer than 2m > Try to use original BMR cables, only
	In case of using RS232	<ul style="list-style-type: none"> > Use the USB-Interface at the PC together with a USB-RS232 converter. > For use with SFU 0303 a specific RS232 cable is required
	In case of using a USB-RS232 converter the USB-driver is not installed correctly.	install driver
	unsure	Restart SFU-Terminal
Start with push buttons not possible	Start button deactivated	Enable Start button by unchecking the checkbox "Block Start Button"
Spindle does not start, in spite of a valid signal for Start	An input is assigned with the function Emergency Stop and configured as "Low Active." > This is default state on delivery	<ul style="list-style-type: none"> > For unlocking, a signal of "HI" / +24V is required at this input. > Deactivate this function or setup as "High Active"
	The evaluation of the temperature sensor is activated in the spindle characteristic, but it is not connected or a sensor isn't implemented within the spindle -> in this case Error is indicated, additionally	<ul style="list-style-type: none"> > Connect the temp sensor wires with the SFU. > uncheck the button "Temp Sensor" in the spindle characteristic in SFU-Terminal
	The spindle test is engaged	<ul style="list-style-type: none"> > Check cable and connections for proper wiring or short circuit > Check spindle

Error Description	Cause	Fixing
Spindle does not start, in spite of a valid signal for Start	Spindle cable and spindle are OK, and the spindle test is activated > Spindle cable is too long With activated spindle test, a test current is send via spindle cable to the spindle by applyng a voltage at output lines. In case that this current is too low, or a wrong spindle characteristic selected, it does not match to the reference values and the spindle test fails.	> Select correct spindle characteristic > In the spindle characteristic the value of the start voltage has to be increased. -> contact BMR
The error message Spindle not ready is indicated.	Spindle is at excess temperature	Let it cool down > Check, if the characteristic matches with the spindle
	PTC in the spindle is defective	change spindle
	The PTC-wires within the spindle cable are defective	exchange cable or fix the connection
Start via Digital Input is not possible	Start via Analogue input is activated.	Deactivate Start via analogue input. -> Manual: "Analogue Inputs" and activate Digital Start
	Set value for duty speed is too low	Increase Analogue value for duty value. > A spindle start is carried out after reaching the required minimum voltage according to the scaling, only
It is displayed Error Char xx or E xx	The selected spindle characteristic at memory place xx is wrong, invalid or corrupted.	> Select matching characteristic with the help of the buttons at the front panel or with SFU-Terminal -> Contact BMR

Error Description	Cause	Fixing
With activated speed sensor: The spindle runs properly, but sometimes there appears the message Encoder Error.	Loose connection in spindle, spindle cable or at the connectors	> Check spindle cable and exchange potentially > Check connectors
	Disturbances on the signal or the signal amplitude is too low > sensor wires in spindle cable are not shielded	> Exchange spindle cable > for verification test exchange spindle
Error Without Spindle, Cable is displayed	Spindle cable is defective	> Check the 3 spindle phase wires
	Spindle cable too long - With activated spindle test, a test current is sent via spindle cable to the spindle by applying a voltage at output lines. In case that this current is too low, or a wrong spindle characteristic selected, it does not match to the reference values and the spindle test fails.	> Check, if the proper characteristic is selected. > Increase value for start voltage in the spindle characteristic -> contact BMR > Deactivate function "Spindle test"

13. General Hints

Our frequency converters are highly valuable precision devices. Please take care of them with the necessary attention, to preserve their high precision, high power ability, and long lifetime.

These devices leave our company only after a quality test and a full load check have been carried out. Before mounting and use, please read the attached manual carefully and pay attention to the points listed below.

- ✓ Before first activation of the device, verify, if it is in a faultless condition. If it was damaged during shipping and transportation it must not be switched on.
- ✓ During installation the safety regulations have to be observed.
- ✓ Before the device is turned on for the first time, it should be verified, that the connected parts cannot carry out uncontrolled movements.
- ✓ The frequency converter must not be operated close to heating devices or magnets or devices generating strong magnetic fields.
- ✓ The maximum permissible ambient temperature of this device is from +41 °F till +104 °F.
- ✓ Sufficient air circulation around the converter should be ensured
- ✓ Fluids should be prevented from intruding into the housing. If it seems to be happened, the converter has to be switched off immediately.
- ✓ The relative humidity must not exceed 90% (not condensed).
- ✓ The ambient air must not use aggressive, flammable or electrically conductive substances and should be as free of dust as possible.
- ✓ All repairs and maintenance on the converter and the relating accessories must be carried out by skilled personal and with powered off, only. To ensure this, the mains plug should be pulled out. In doing this, both the terms of regulations for preventing accidents and the general and national rules for mounting and safety have to be applied.
- ✓ The device must not be operated without properly connected PE connection and it has to be verified that the mains connector is fixed with screws, if detachable.

Our common hints can give only a rough guideline because it is not possible for **BMR GmbH** to cover all specific situations. The compliance with limits of EMC demanded by law is the responsibility of the manufacturer of the unit or the machine. By doing controls and tests in our laboratory or in delegated test-laboratories, BMR takes care, that our products comply with the corresponding standards, in case they are installed appropriately.

14. Warranty

With exclusion of additional claims we give a warranty on our Frequency Converters for 1 year on errors due to material, mounting and construction.

We commit to repair or replace the parts without any costs which seem to be defective by our estimation and which are not damaged by appropriate handling.

Warranty claims have to be sent to us in written form. The customer has to pay the costs to send the defective device back to BMR within the time of warranty. If this is not complied with or if we detect an external intrusion into our device, we feel free to withdraw our duty of warranty.

Our duty of warranty is limited to the repairing or replacing of the defective parts. We refuse claims of responsibility or warranty for direct or indirect consequential damages, caused by faults of our products.

Changes in construction may be carried out without any message or notification. Our common terms of business conditions apply.

BMR GmbH is a dynamic and flexible company. We take into account specific requirements of our customers as well as demanding solutions in design. These are integrated according to qualitative and functional aspects maintaining of course our high quality standard.

Our company is working according to the highest economical and ecological standards which are mirrored at **BMR GmbH** in all areas. Especially in manufacturing we try to improve steadily our ecological standard. It has been and is our constant purpose to comply with these demands.

15. Accessories

Name	Order code
RS232 Cable	P 2001.100012
USB Cable	P 2001.100013
RS485 Cable	P 2001.100014
LCD Operating Panel	P 1203.100003
Mounting Bracket for the Housing	P 1700.504133
Kit of pluggable Connection Clamps for X2, X3, X4, Mains and spindle connector	P 1001.100005
Mounting Bracket and 2 Clamps for fixing the cables and for establishing the cable shielding	P 1001.100006

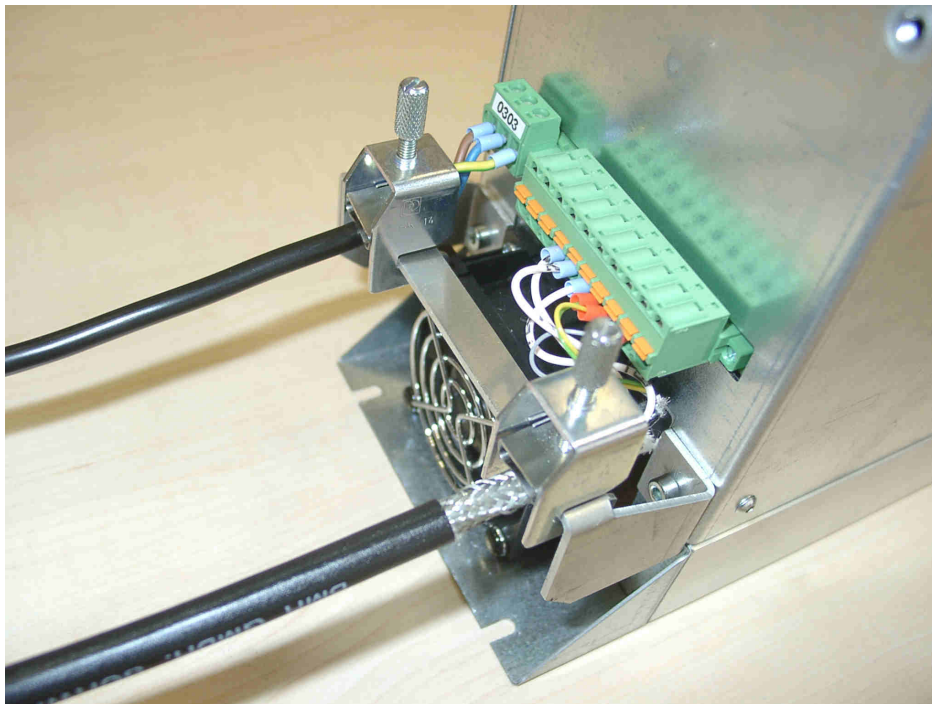

Mounting of cable clamps at the mounting brackets for mains and spindle cables

16. Mechanic, Views and Dimension

16.1 SSE Version for cabinet mounting

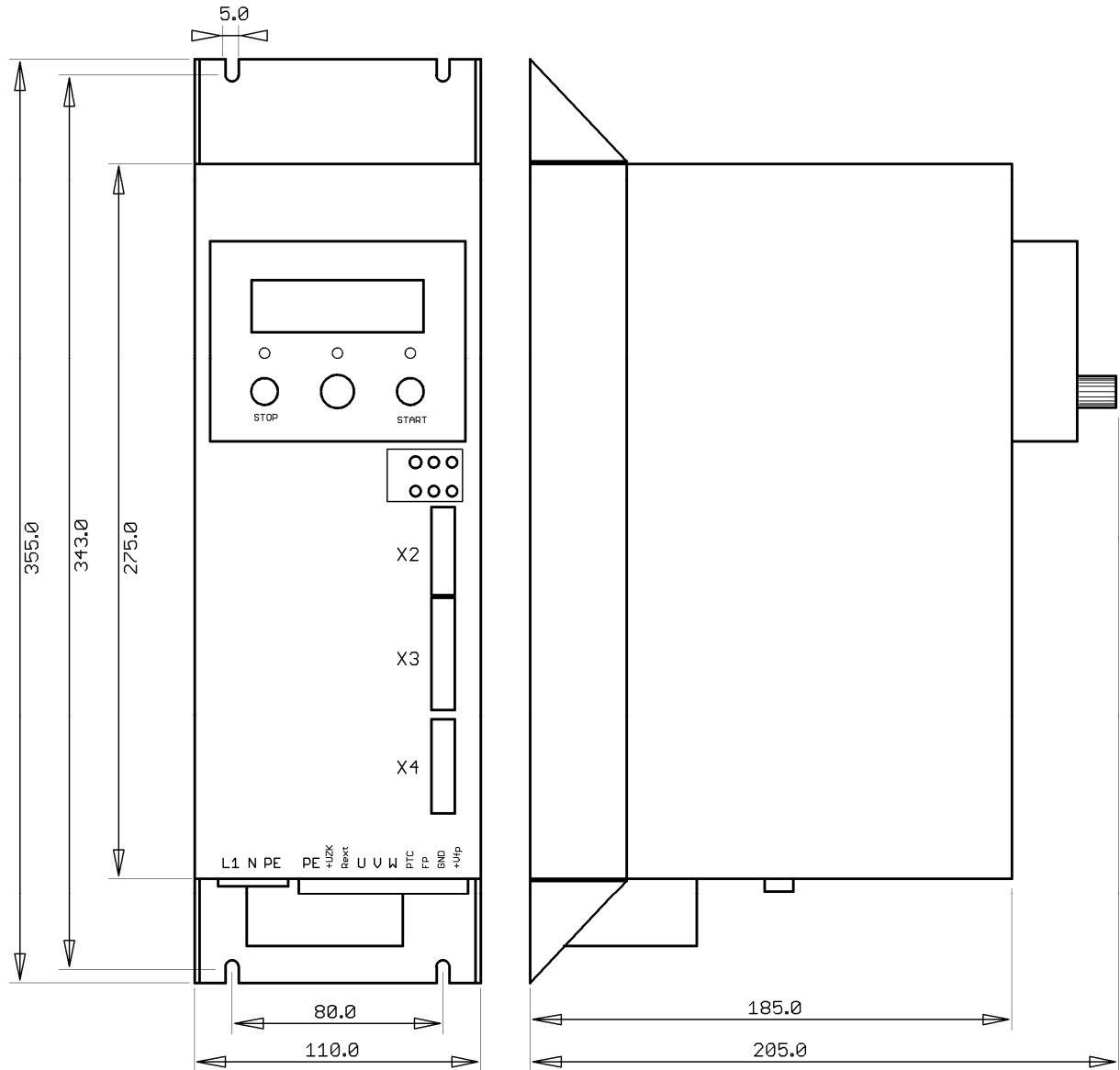

16.2 19" Version

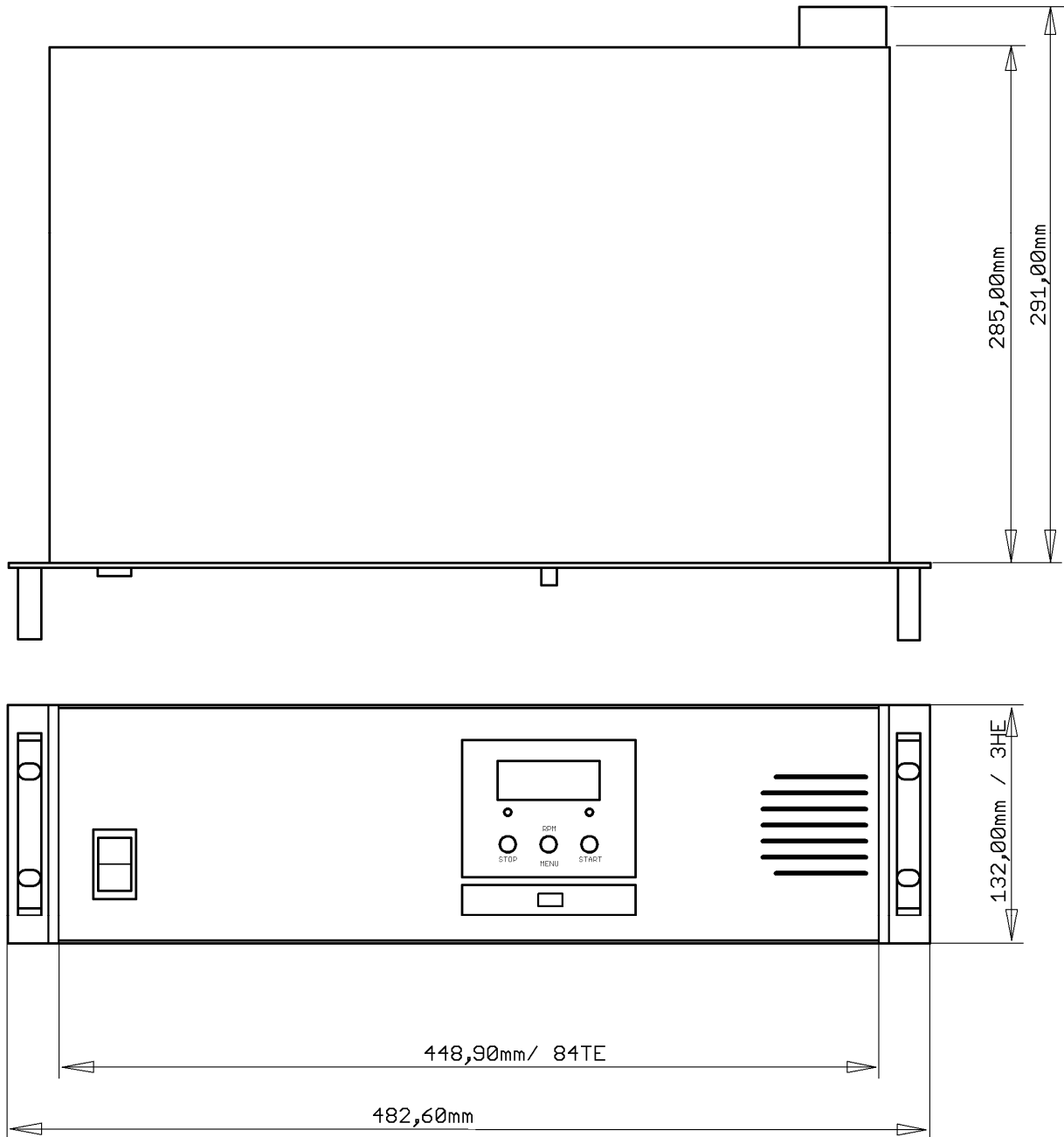

16.3 Version Desktop

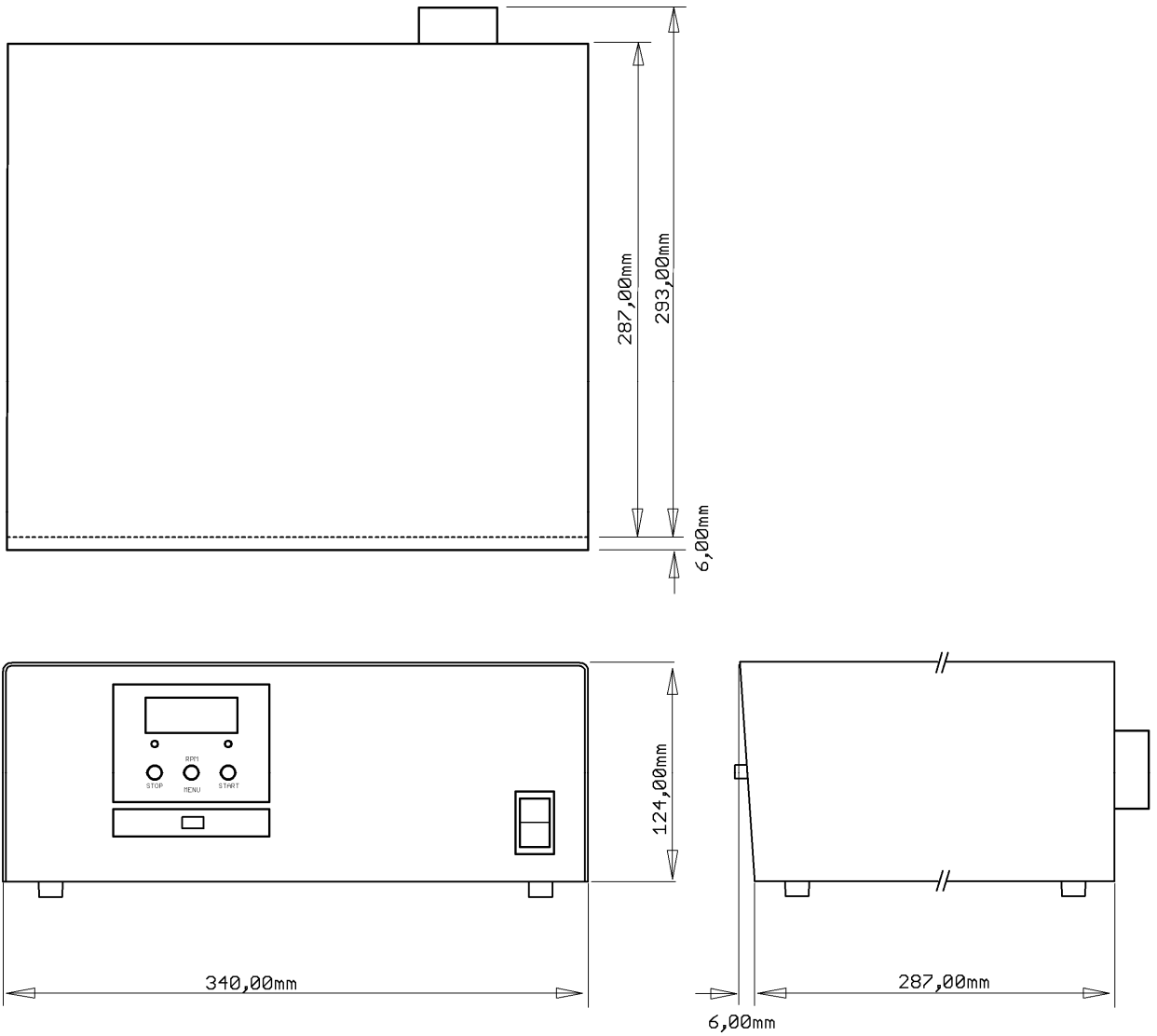

16.4 Version Desktop 63TE

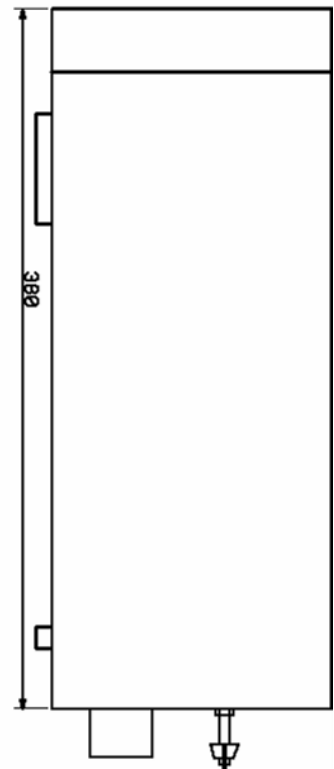
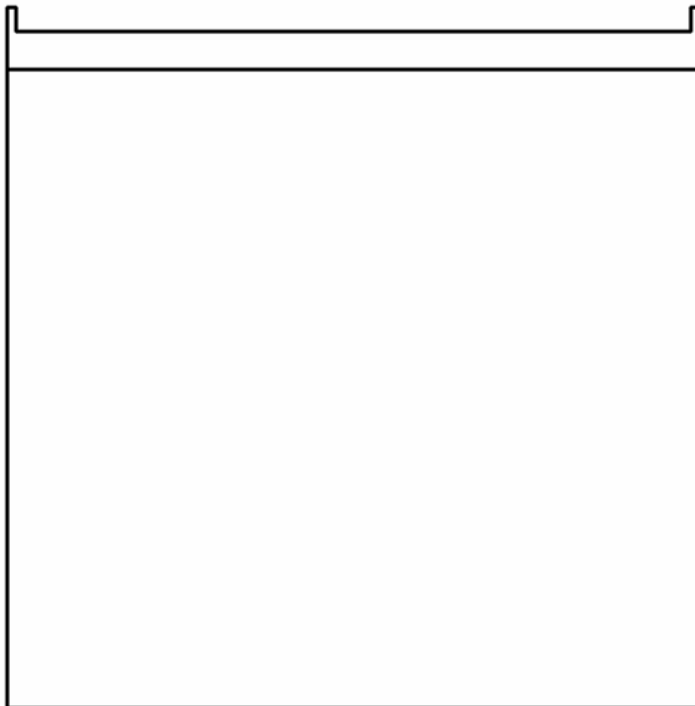
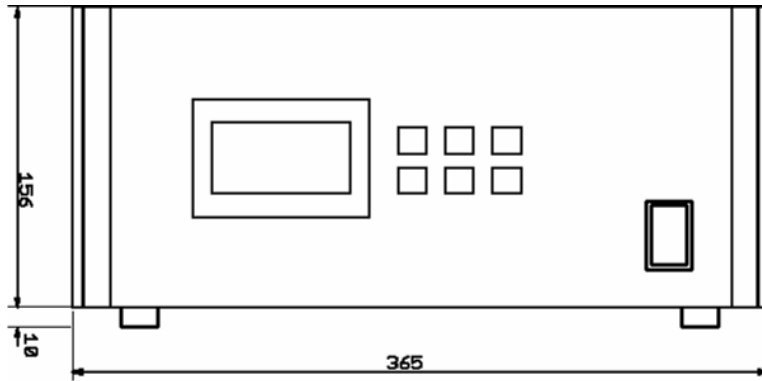

ONE PRODUCT IS NOT ENOUGH MORE PRODUCTS OF BMR GMBH

Cooling Unit KG-T 500

Nominal Voltage:	100 - 250 V _{AC} / f=50Hz
Start Input Voltage:	max. 24 V _{DC}
Max. power input:	max. 80W
Max. cooling power:	max. 500W (by ambient temperature<23°C)
Relais details:	max. 30W (30V _{DC} / 1A)
Fuses:	2 A



The cooling unit KG-T 500 is controlled by an internal microprocessor. It has been designed to run high speed spindles like in cool ambience conditions. You are able to use it nearly for all types of spindles and cooling blocks. The maximum range of spindle power is 2000W.

SFU 0156 „Remote-Control“

Als Option ist ein Fernsteuer-Adapter zum direkten Anschluss an das I/O Interface an der Stiftleiste SL2 verfügbar.



- ✓ On option a remote controller is available which can directly be connected with the I/O interface at SL2. By this, the required duty speed can be adjusted with a potentiometer and the converter can be started and stopped with a rocker switch. The status of the digital outputs is indicated on LEDs.
- ✓ All required voltages are generated within this adapter, so the converter can be controlled and tested very easily. A quick test and setting into action of the converter becomes possible even without external control signals.

Spindle-Illumination-Ring

Don't you know the problem, that despite of lighting systems, exactly at the point where you need to see something, a shadow appears or there is too less light?



With the new spindle illumination ring of BMR GmbH this problem belongs to the past!

Spindles

High - frequency spindles are essential in today's adaption technology. Each application requires a specific solution.



...and many more!

OUR QUALITY COMMITMENT

100%	„Made in Germany“
100%	precision
100%	reliability
100%	support
100%	flexibility



**Subject to technical alterations.
May 2017**



ANSPRECHPARTNER CONTACT

FON 09122 / 631 48 - 0
FAX 09122 / 631 48 - 29

BMR GmbH elektrischer & elektronischer Gerätebau

Walpersdorfer Straße 38
91126 Schwabach

E-Mail info@bmr-gmbh.de
Homepage www.bmr-gmbh.de

GESCHÄFTSFÜHRUNG MANAGEMENT

Susanne Brittlng
s.brittlng@bmr-gmbh.de

ENTWICKLUNGSABTEILUNG DEVELOPMENT DEPARTMENT

Franz Lebski
f.lebski@bmr-gmbh.de

Frank Buchholz
f.buchholz@bmr-gmbh.de

Markus Neidert-Loy
m.neidert-loy@bmr-gmbh.de

Stephan Brittlng
stephan.brittlng@bmr-gmbh.de

EINKAUF/REPARATURSERVICE PURCHASE / REPAIR-SERVICE

Vera Wallert
v.wallert@bmr-gmbh.de

VERTRIEB SALES

Michael Lämmermann
m.laemmermann@bmr-gmbh.de

Annette Farbulleh
a.farbulleh@bmr-gmbh.de

Rudolf M. Brittlng
r.brittlng@bmr-gmbh.de

